

HerAy Filtrasyon ve Su Teknoloji Sistemleri

1989 yılında Konya 'da şahıs şirketi olarak kurulan firmamız 1994 yılından itibaren kurumsal şirket kimliği ile faaliyetlerine devam etmektedir.



Yüksek kalitede Su filtrasyonu ve su arıtması üretimi yapan HERAY, Türkiye ve çevre ülkelerde sektöründe lider marka olan HERAY, çeşitli endüstriler, belediyeler ve tarım sektörü için su filtreleri ve arıtma tesisleri tasarlar ve üretir. Ar&Ge altyapısı ve Teknokent Üniversite – Sanayi İş Birliği sayesinde karşılaşılabilecek farklı uygulamalar da yenilikçi ve özel yapım çözümler sunmaktadır.



Şirketimizin sürdürülebilir anlayışı, insanlığa hizmeti kutsal sayan değerlerimizle her bir damla suya değer katarak su kaynaklarımızı daha verimli kullanarak çevremizi korumaya yardımcı olmak için sürekli olarak yeni teknolojiler geliştirmektedir.

14.000 m2 kapalı olmak üzere toplamda 23.000 m2 olan üretim tesisinde son teknolojiye sahip makinelerle üretim yapan HERAY, alanında uzman 20 mühendis ve eğitilmiş 200 personeli ile tüm prosesleri bünyesinde yapmaktadır. Mühendislik ekibimizin yeni çözümler geliştirmesini veya mevcut çözümlerin müşterinin ihtiyacına göre ayarlanmasını kolaylaştıran, su filtrasyon ve su arıtma pazarındaki en gelişmiş üretim yöntemlerini kullanan üretim hattımızla ve 4 kıtaya yaptığımız ihracat ile gurur duyuyoruz.

Suya değer katan teknoloji.

PRIMESCREEN

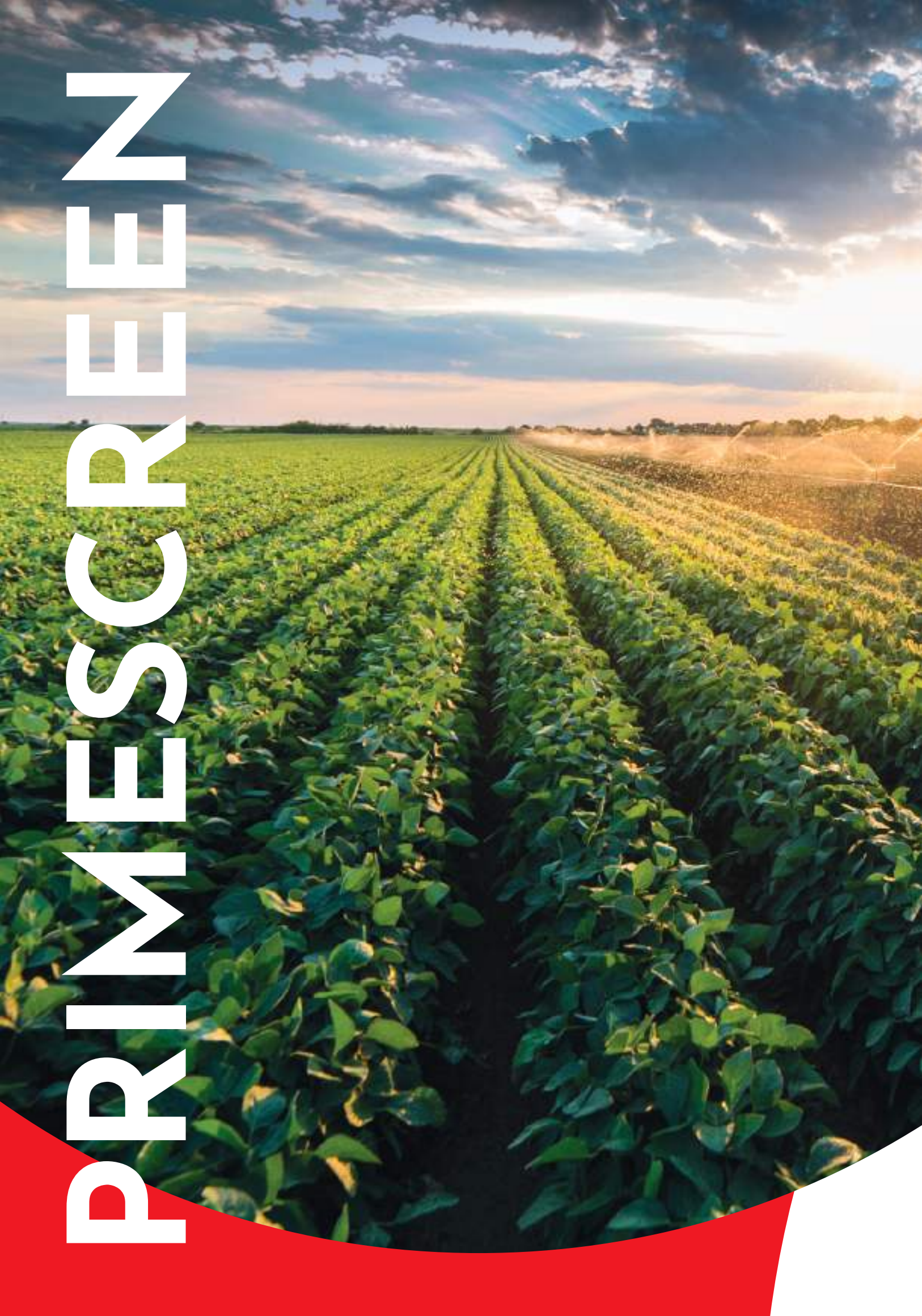



heray.com.tr

PRIMESCREEN
OTOMATİK ELEK FİLTRELER
VE SİSTEMLER



PRIMESCREEN OTOMATİK ELEK FİLTRELER

Elektronik Kontrol / Yatay Tip Otomatik Filtreler



ÜRÜN KODU	GİRİŞ/ÇIKIŞ (INCH)	FİLTASYON ALANI (CM2)	DEBİ (M3/H) MAX.
TFS-416	4" / DN100	4800 / LP	100
TFS-419	4" / DN100	7200 / XLP	120
TFS-516	5" / DN125	4800 / LP	130
TFS-519	5" / DN125	7200 / XLP	140
TFS-616	6" / DN150	4800 / LP	160
TFS-619	6" / DN150	7200 / XLP	200
TFS-819	8" / DN200	7200 / XLP	300
TFS-1019	10" / DN250	7200 / XLP	380

Elektronik Kontrol / Dikey Tip Otomatik Filtreler



ÜRÜN KODU	GİRİŞ/ÇIKIŞ (INCH)	FİLTASYON ALANI (CM2)	DEBİ (M3/H) MAX.
TFS-200	2" / DN50	1600 / MP	20
TFS-251	2 1/2" / DN65	2400 / MP	35
TFS-310	3" / DN80	2400 / MP	45
TFS-410	4" / DN100	2400 / MP	75

Elektronik Kontrol / Paslanmaz Yatay Tip Otomatik Filtreler



ÜRÜN KODU	GİRİŞ/ÇIKIŞ (INCH)	FİLTASYON ALANI (CM2)	DEBİ (M3/H) MAX.
TFX-416	4" / DN100	4800 / LP	100
TFX-419	4" / DN100	7200 / XLP	120
TFX-516	5" / DN125	4800 / LP	130
TFX-519	5" / DN125	7200 / XLP	140
TFX-616	6" / DN150	4800 / LP	160
TFX-619	6" / DN150	7200 / XLP	200
TFX-819	8" / DN200	7200 / XLP	300
TFX-1019	10" / DN250	7200 / XLP	380

Elektronik Kontrol / Paslanmaz Dikey Tip Otomatik Filtreler



ÜRÜN KODU	GİRİŞ/ÇIKIŞ (INCH)	FİLTASYON ALANI (CM2)	DEBİ (M3/H) MAX.
TFX-200	2" / DN50	1600 / MP	20
TFX-251	2 1/2" / DN65	2400 / MP	35
TFX-310	3" / DN80	2400 / MP	45
TFX-410	4" / DN100	2400 / MP	75

PRIMESCREEN OTOMATİK ELEK FİLTRELER

Motor Kontrollü Yatay Tip Otomatik Filtreler



ÜRÜN KODU	GİRİŞ/ÇIKIŞ (INCH)	FİLTASYON ALANI (CM2)	DEBİ (M3/H) MAX.
TFM-416	4" / DN100	4800 / LP	100
TFM-419	4" / DN100	7200 / XLP	120
TFM-516	5" / DN125	4800 / LP	130
TFM-519	5" / DN125	7200 / XLP	140
TFM-616	6" / DN150	4800 / LP	160
TFM-619	6" / DN150	7200 / XLP	200
TFM-819	8" / DN200	7200 / XLP	300
TFM-1019	10" / DN250	7200 / XLP	380

Elektronik Kontrol Çoklu Tip Otomatik Filtreler



ÜRÜN KODU	GİRİŞ/ÇIKIŞ (INCH)	FİLTASYON ALANI (CM2)	DEBİ (M3/H) MAX.
TFS-1029	10" / DN250	14.400	400
TFS-1239	12" / DN300	21.600	600
TFS-1449	14" / DN350	28.800	800
TFS-1669	16" / DN400	43.200	1200

Yatay Tip Otomatik Filtre Primesiklon ve Manifold Seti



Manifold Seti
(Giriş Viktaulik, Çıkış Flanş)

ÜRÜN KODU	GİRİŞ/ÇIKIŞ (INCH)	AÇIKLAMA
TF-400	4" / DN100	Oto. Filtre Manifold Seti
TF-500	5" / DN125	Oto. Filtre Manifold Seti
TF-600	6" / DN150	Oto. Filtre Manifold Seti
TF-800	8" / DN200	Oto. Filtre Manifold Seti

ÜRÜN KODU	GİRİŞ/ÇIKIŞ (INCH)	AÇIKLAMA
TFP-400	4" / DN100	Oto. Filtre Primesiklon Seti
TFP-500	5" / DN125	Oto. Filtre Primesiklon Seti
TFP-600	6" / DN150	Oto. Filtre Primesiklon Seti
TFP-800	8" / DN200	Oto. Filtre Primesiklon Seti

Primesiklon ve Manifold Seti
(Giriş - Çıkış Flanş)

PRIMESCREEN OTOMATİK ELEK FİLTRELER



Elektronik Kontrol / Primesiklon ve Primescreen Filtreli Otomatik Filtre Sistemler

ÜRÜN KODU	GİRİŞ/ÇIKIŞ (INCH)	OTOMATİK FİLTRE BOYUTU	DEBİ (M3/H) MİN. - MAX.
TPH-416	4" / Manşon	LP	50 - 85
TPH-516	5" / Manşon	LP	90 - 130
TPH-616	6" / Manşon	LP	120 - 160
TPH-619	6" / Manşon	XLP	120 - 185
TPH-819	8" / Flanş	XLP	180 - 300



Elektronik Kontrol / Separatör ve Primescreen Filtreli Otomatik Filtre Sistemler

ÜRÜN KODU	GİRİŞ/ÇIKIŞ (INCH)	OTOMATİK FİLTRE BOYUTU	DEBİ (M3/H) MİN. - MAX.
TSH-416	4" / Manşon	LP	50 - 85
TSH-516	5" / Manşon	LP	90 - 130
TSH-616	6" / Manşon	LP	120 - 160
TSH-619	6" / Manşon	XLP	120 - 185
TSH-819	8" / Flanş	XLP	180 - 260



Elektronik Kontrol / Hidrosiklon ve Primescreen Filtreli Otomatik Filtre Sistemler

ÜRÜN KODU	GİRİŞ/ÇIKIŞ (INCH)	OTOMATİK FİLTRE BOYUTU	DEBİ (M3/H) MİN. - MAX.
TFH-416	4" / Manşon	LP	50 - 85
TFH-516	5" / Manşon	LP	90 - 130
TFH-616	6" / Manşon	LP	120 - 160
TFH-619	6" / Manşon	XLP	120 - 185
TFH-819	8" / Flanş	XLP	180 - 260

PRIMESCREEN OTOMATİK ELEK FİLTRELER



Elektronik Kontrol / Primesiklon ve Primescreen Filtreli Otomatik Filtre Sistemler

ÜRÜN KODU	GİRİŞ/ÇIKIŞ (INCH)	OTOMATİK FİLTRE BOYUTU	DEBİ (M3/H) MİN. - MAX.
TPH-251	2 1/2" Manşon	MP	20 - 35
TPH-310	3" Manşon	MP	30 - 45
TPH-410	4" Manşon	MP	50 - 75



Elektronik Kontrol / Separatör ve Primescreen Filtreli Otomatik Filtre Sistemler

ÜRÜN KODU	GİRİŞ/ÇIKIŞ (INCH)	OTOMATİK FİLTRE BOYUTU	DEBİ (M3/H) MİN. - MAX.
TSH-251	2 1/2" Manşon	MP	20 - 35
TSH-310	3" Manşon	MP	30 - 45
TSH-410	4" Manşon	MP	50 - 75



Elektronik Kontrol / Hidrosiklon ve Primescreen Filtreli Otomatik Filtre Sistemler

ÜRÜN KODU	GİRİŞ/ÇIKIŞ (INCH)	OTOMATİK FİLTRE BOYUTU	DEBİ (M3/H) MİN. - MAX.
TFH-251	2 1/2" Manşon	MP	20 - 35
TFH-310	3" Manşon	MP	30 - 45
TFH-410	4" Manşon	MP	50 - 75

HIDROSIKLON (SEPERATÖR)

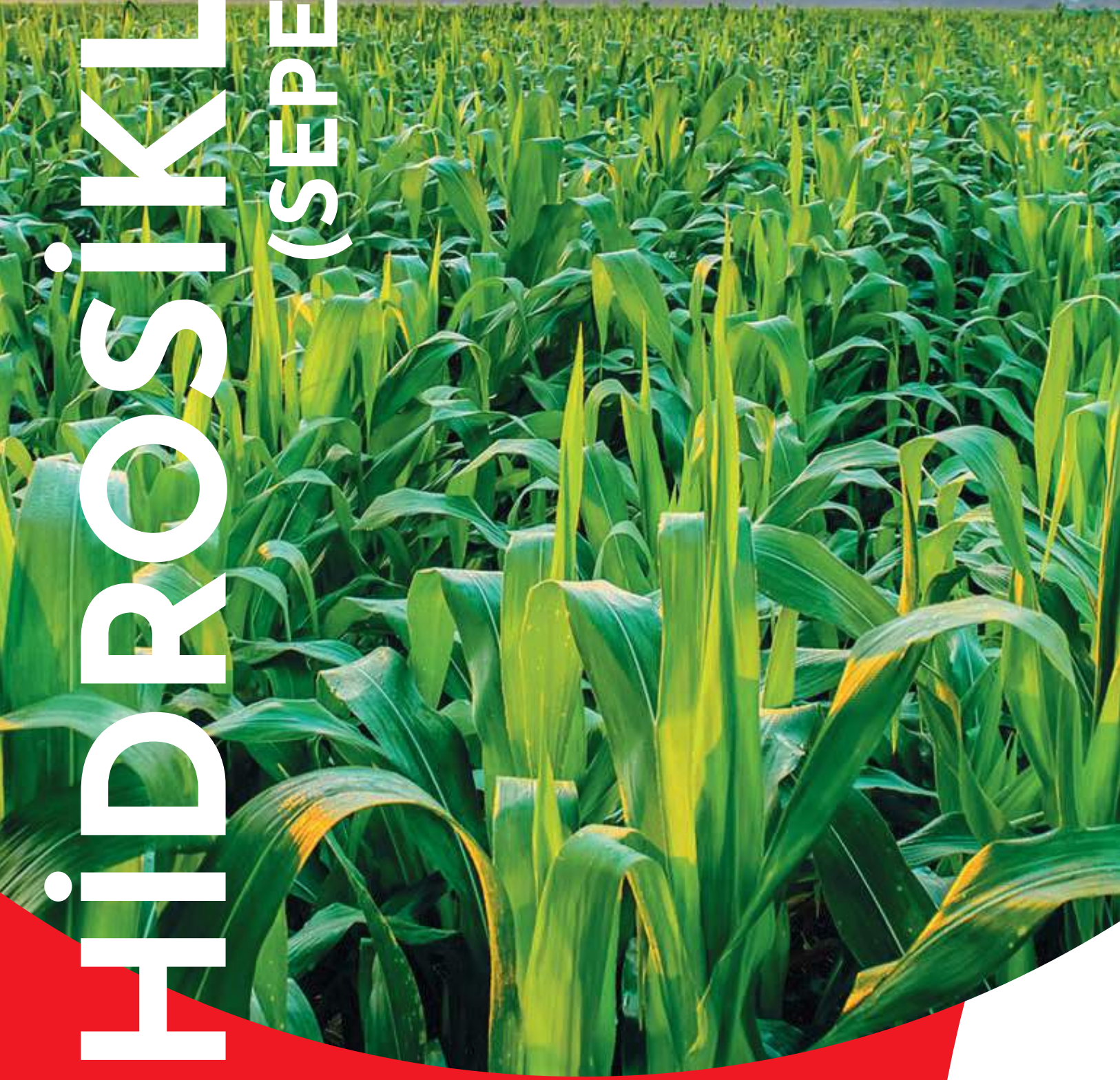



heray.com.tr

HİDROSİKLO DİSK FİLTRELİ HİDROSİKLO SİSTEMLER



Hidrosiklon (Seperatör)



Primesiklonlar

ÜRÜN KODU	GİRİŞ/ÇIKIŞ (INCH)	DEBİ (M3/H) MİN. - MAX.	KUM TANKI HACMİ (LT)
PS-200	2" Manşon	11 -- 20	15
PS-250	2 1/2" Manşon	20 - 30	15
PS-300	3" Manşon	30 - 45	15
PS-400	4" Manşon	55 - 85	30
PS-500	5" Manşon	100 - 135	80
PS-600	6" Manşon	135 -185	80
PS-800	8" Flanş	200 - 300	150



Separatörler

ÜRÜN KODU	GİRİŞ/ÇIKIŞ (INCH)	DEBİ (M3/H) MİN. - MAX.
HD-151	1 1/2" Nipel	3.5 - 7.5
HD-201	2" Manşon	11 -- 20
HD-251	2 1/2" Manşon	20 - 30
HD-301	3" Manşon	30 - 45
HD-401	4" Manşon	55 - 85
HD-501	5" Manşon	100 - 135
HD-601	6" Manşon	135 -185
HD-801	8" Flanş	200 - 300



Hidrosiklonlar

ÜRÜN KODU	GİRİŞ/ÇIKIŞ (INCH)	DEBİ (M3/H) MİN. - MAX.	KUM TANKI HACMİ (LT)
HD-100	1" Nipel	3.5 - 7.5	2.5
HD-150	1 1/2" Nipel	7.5 -- 12	5
HD-200	2" Manşon	11 -- 20	20
HD-250	2 1/2" Manşon	20 - 30	20
HD-300	3" Manşon	30 - 45	20
HD-400	4" Manşon	55 - 85	60
HD-500	5" Manşon	100 - 135	120
HD-600	6" Manşon	135 -185	120
HD-800	8" Flanş	200 - 300	150

Hidrosiklon (Seperatör)



Primesiklon Sistem Önü

ÜRÜN KODU	GİRİŞ/ÇIKIŞ (INCH)	DEBİ (M3/H) MİN. - MAX.
PS-201	2" Manşon	11 -- 20
PS-251	2 1/2" Manşon	20 - 30
PS-301	3" Manşon	30 - 45
PS-401	4" Manşon	55 - 85
PS-501	5" Manşon	100 - 135
PS-601	6" Manşon	135 -185
PS-801	8" Flanş	200 - 300



Separatör Sistem Önü

ÜRÜN KODU	GİRİŞ/ÇIKIŞ (INCH)	DEBİ (M3/H) MİN. - MAX.
HB-201	2" Manşon	11 -- 20
HB-251	2 1/2" Manşon	20 - 30
HB-301	3" Manşon	30 - 45
HB-401	4" Manşon	55 - 85
HB-501	5" Manşon	100 - 135
HB-601	6" Manşon	135 -185
HB-801	8" Flanş	200 - 300



Hidrosiklon Sistem Önü

ÜRÜN KODU	GİRİŞ/ÇIKIŞ (INCH)	DEBİ (M3/H) MİN. - MAX.	KUM TANKI HACMİ (LT)
HB-200	2" Manşon	11 -- 20	-
HB-250	2 1/2" Manşon	20 - 30	-
HB-300	3" Manşon	30 - 45	-
HB-400	4" Manşon	55 - 85	-
HB-500	5" Manşon	100 - 135	-
HB-600	6" Manşon	135 -185	-
HB-800	8" Flanş	200 - 300	-

Hidrosiklon (Seperatör)



Tek Plastik Disk Filtreli Primesiklon Sistemler

ÜRÜN KODU	GİRİŞ/ÇIKIŞ (INCH)	DEBİ (M3/H) MİN. - MAX.
PP-200	2" Manşon	11 -- 20
PP-250	2 1/2" Manşon	20 - 30
PP-300	3" Manşon	30 - 45



İkiz Plastik Disk Filtreli Primesiklon Sistemler

ÜRÜN KODU	GİRİŞ/ÇIKIŞ (INCH)	DEBİ (M3/H) MİN. - MAX.
PP-301	3" Manşon	30 - 45
PP-400	4" Manşon	55 - 80



Tek Plastik Disk Filtreli Seperatör Sistemler

ÜRÜN KODU	GİRİŞ/ÇIKIŞ (INCH)	DEBİ (M3/H) MİN. - MAX.
HS-200	2" Manşon	11 -- 20
HS-250	2 1/2" Manşon	20 - 30
HS-300	3" Manşon	30 - 45



İkiz Plastik Disk Filtreli Seperatör Sistemler

ÜRÜN KODU	GİRİŞ/ÇIKIŞ (INCH)	DEBİ (M3/H) MİN. - MAX.
HS-301	3" Manşon	30 - 45
HS-400	4" Manşon	55 - 80

Hidosiklon (Seperatör)



Tek Plastik Disk Filtreli Hidosiklon Sistemler

ÜRÜN KODU	GİRİŞ/ÇIKIŞ (INCH)	DEBİ (M3/H) MİN. - MAX.	DİSK FİLTRE
HP-200	2" Manşon	11 -- 20	-
HP-250	2 1/2" Manşon	20 - 30	-
HP-300	3" Manşon	30 - 45	-



İkiz Plastik Disk Filtreli Hidosiklon Sistemler

ÜRÜN KODU	GİRİŞ/ÇIKIŞ (INCH)	DEBİ (M3/H) MİN. - MAX.
HP-301	3" Manşon	30 - 45
HP-400	4" Manşon	55 - 80



Metal Disk Filtreli Hidosiklon Sistemler

ÜRÜN KODU	GİRİŞ/ÇIKIŞ (INCH)	DEBİ (M3/H) MİN. - MAX.
HY-200	2" Manşon	11 -- 20
HY-250	2 1/2" Manşon	20 - 30
HY-300	3" Manşon	30 - 45
HY-400	4" Manşon	55 - 60



İkiz Metal Disk Filtreli Hidosiklon Sistemler

ÜRÜN KODU	GİRİŞ/ÇIKIŞ (INCH)	DEBİ (M3/H) MİN. - MAX.
HK-300	3" Manşon	30 - 45
HK-400	4" Manşon	55 - 80
HK-500	5" Manşon	80 - 100
HK-600	6" Manşon	100 - 120

Hidrosiklon (Seperatör)



Yarı Otomatik / Primesiklonlu ve Tek Plastik Disk Filtreli Sistemler

ÜRÜN KODU	GİRİŞ/ÇIKIŞ (INCH)	FİLTRE SAYISI VE ÇAPI	DEBİ (M3/H) MİN. - MAX.
PP-302	3" Manşon	2 Ad. 3"	25 - 45
PP-402	4" Manşon	2 Ad. 3"	55 - 70
PP-403	4" Manşon	3 Ad. 3"	55 - 85
PP-504	5" Manşon	4 Ad. 3"	100 - 130
PP-604	6" Manşon	4 Ad. 3"	135 - 140
PP-605	6" Manşon	5 Ad. 3"	135 - 185



Yarı Otomatik / Primesiklonlu ve İkiz Plastik Disk Filtreli Sistemler

ÜRÜN KODU	GİRİŞ/ÇIKIŞ (INCH)	FİLTRE SAYISI VE ÇAPI	DEBİ (M3/H) MİN. - MAX.
PP-423	4" Manşon	2 Ad. 3"	55 - 85
PP-524	5" Manşon	2 Ad. 4"	100 - 120
PP-534	5" Manşon	3 Ad. 4"	100 - 135
PP-634	6" Manşon	3 Ad. 4"	135 - 160
PP-644	6" Manşon	4 Ad. 4"	135 - 185
PP-654	6" Manşon	5 Ad. 4"	135 - 195
PP-844	8" Flanş	4 Ad. 4"	200 - 250
PP-854	8" Flanş	5 Ad. 4"	200 - 300



Yarı Otomatik / Primesiklonlu ve Metal Disk Filtreli Sistemler

ÜRÜN KODU	GİRİŞ/ÇIKIŞ (INCH)	FİLTRE SAYISI VE ÇAPI	DEBİ (M3/H) MİN. - MAX.
PY-423	4" Manşon	2 Ad. 3"	55 - 70
PY-433	4" Manşon	3 Ad. 3"	55 - 85
PY-534	5" Manşon	3 Ad. 4"	100 - 135
PY-644	6" Manşon	4 Ad. 4"	135 - 150
PY-654	6" Manşon	5 Ad. 4"	135 - 185

Hidrosiklon (Seperatör)

Tam Otomatik / Primesiklonlu ve Tek Plastik Disk Filtreli Sistemler



ÜRÜN KODU	GİRİŞ/ÇIKIŞ (INCH)	FİLTRE SAYISI VE ÇAPI	DEBİ (M3/H) MİN. - MAX.
PPO-302	3" Manşon	2 Ad. 3"	25 - 45
PPO-402	4" Manşon	2 Ad. 3"	55 - 70
PPO-403	4" Manşon	3 Ad. 3"	55 - 85
PPO-504	5" Manşon	4 Ad. 3"	100 - 130
PPO-604	6" Manşon	4 Ad. 3"	135 - 140
PPO-605	6" Manşon	5 Ad. 3"	135 - 185

Tam Otomatik / Primesiklonlu ve İkiz Plastik Disk Filtreli Sistemler



ÜRÜN KODU	GİRİŞ/ÇIKIŞ (INCH)	FİLTRE SAYISI VE ÇAPI	DEBİ (M3/H) MİN. - MAX.
PPO-423	4" Manşon	2 Ad. 3"	55 - 85
PPO-524	5" Manşon	2 Ad. 4"	100 - 120
PPO-534	5" Manşon	3 Ad. 4"	100 - 135
PPO-634	6" Manşon	3 Ad. 4"	135 - 160
PPO-644	6" Manşon	4 Ad. 4"	135 - 185
PPO-654	6" Manşon	5 Ad. 4"	135 - 195
PPO-844	8" Flanş	4 Ad. 4"	200 - 250
PPO-854	8" Flanş	5 Ad. 4"	200 - 300

Tam Otomatik / Primesiklonlu ve Metal Disk Filtreli Sistemler



ÜRÜN KODU	GİRİŞ/ÇIKIŞ (INCH)	FİLTRE SAYISI VE ÇAPI	DEBİ (M3/H) MİN. - MAX.
PYO-423	4" Manşon	2 Ad. 3"	55 - 70
PYO-433	4" Manşon	3 Ad. 3"	55 - 85
PYO-534	5" Manşon	3 Ad. 4"	100 - 135
PYO-644	6" Manşon	4 Ad. 4"	135 - 150
PYO-654	6" Manşon	5 Ad. 4"	135 - 185

Hidrosiklon (Seperatör)



Yarı Otomatik / Seperatörlü ve Tek Plastik Disk Filtreli Sistemler

ÜRÜN KODU	GİRİŞ/ÇIKIŞ (INCH)	FİLTRE SAYISI VE ÇAPI	DEBİ (M3/H) MİN. - MAX.
SP-302	3" Manşon	2 Ad. 3"	25 - 45
SP-402	4" Manşon	2 Ad. 3"	55 - 70
SP-403	4" Manşon	3 Ad. 3"	55 - 85
SP-504	5" Manşon	4 Ad. 3"	100 - 130
SP-604	6" Manşon	4 Ad. 3"	135 - 140
SP-605	6" Manşon	5 Ad. 3"	135 - 185



Yarı Otomatik / Seperatörlü ve İkiz Plastik Disk Filtreli Sistemler

ÜRÜN KODU	GİRİŞ/ÇIKIŞ (INCH)	FİLTRE SAYISI VE ÇAPI	DEBİ (M3/H) MİN. - MAX.
SP-423	4" Manşon	2 Ad. 3"	55 - 85
SP-524	5" Manşon	2 Ad. 4"	100 - 120
SP-534	5" Manşon	3 Ad. 4"	100 - 135
SP-634	6" Manşon	3 Ad. 4"	135 - 160
SP-644	6" Manşon	4 Ad. 4"	135 - 185
SP-654	6" Manşon	5 Ad. 4"	135 - 195
SP-844	6" Manşon	4 Ad. 4"	200 - 250
SP-854	8" Flanş	5 Ad. 4"	200 - 300



Yarı Otomatik / Seperatörlü ve Metal Disk Filtreli Sistemler

ÜRÜN KODU	GİRİŞ/ÇIKIŞ (INCH)	FİLTRE SAYISI VE ÇAPI	DEBİ (M3/H) MİN. - MAX.
SY-423	4" Manşon	2 Ad. 3"	55 - 70
SY-433	4" Manşon	3 Ad. 3"	55 - 85
SY-534	5" Manşon	3 Ad. 4"	100 - 135
SY-644	6" Manşon	4 Ad. 4"	135 - 150
SY-654	6" Manşon	5 Ad. 4"	135 - 185

Hidrosiklon (Seperatör)



Tam Otomatik / Seperatörlü ve Tek Plastik Disk Filtreli Sistemler

ÜRÜN KODU	GİRİŞ/ÇIKIŞ (INCH)	FİLTRE SAYISI VE ÇAPI	DEBİ (M3/H) MİN. - MAX.
SPO-402	4" Manşon	2 Ad. 3"	55 - 70
SPO-403	4" Manşon	3 Ad. 3"	55 - 85
SPO-503	5" Manşon	3 Ad. 3"	100 - 135
SPO-604	6" Manşon	4 Ad. 3"	135 - 150
SPO-605	6" Manşon	5 Ad. 3"	135 - 185



Tam Otomatik / Seperatörlü ve İkiz Plastik Disk Filtreli Sistemler

ÜRÜN KODU	GİRİŞ/ÇIKIŞ (INCH)	FİLTRE SAYISI VE ÇAPI	DEBİ (M3/H) MİN. - MAX.
SPO-423	4" Manşon	2 Ad. 3"	55 - 85
SPO-524	5" Manşon	2 Ad. 4"	100 - 120
SPO-534	5" Manşon	3 Ad. 4"	100 - 135
SPO-634	6" Manşon	3 Ad. 4"	135 - 160
SPO-644	6" Manşon	4 Ad. 4"	135 - 185
SPO-654	6" Manşon	5 Ad. 4"	135 - 195
SPO-844	6" Manşon	4 Ad. 4"	200 - 250
SPO-854	8" Flanş	5 Ad. 4"	200 - 300



Tam Otomatik / Seperatörlü ve Metal Disk Filtreli Sistemler

ÜRÜN KODU	GİRİŞ/ÇIKIŞ (INCH)	FİLTRE SAYISI VE ÇAPI	DEBİ (M3/H) MİN. - MAX.
SYO-423	4" Manşon	2 Ad. 3"	55 - 70
SYO-433	4" Manşon	3 Ad. 3"	55 - 85
SYO-534	5" Manşon	3 Ad. 4"	100 - 135
SYO-644	6" Manşon	4 Ad. 4"	135 - 150
SYO-654	6" Manşon	5 Ad. 4"	135 - 185

Hidrosiklon (Seperatör)



Yarı Otomatik / Hidrosiklonlu ve Tek Plastik Disk Filtreli Sistemler

ÜRÜN KODU	GİRİŞ/ÇIKIŞ (INCH)	FİLTRE SAYISI VE ÇAPI	DEBİ (M3/H) MİN. - MAX.
HP-302	3" Manşon	2 Ad. 3"	25 - 45
HP-402	4" Manşon	2 Ad. 3"	55 - 70
HP-403	4" Manşon	3 Ad. 3"	55 - 85
HP-504	5" Manşon	4 Ad. 3"	100 - 130
HP-604	6" Manşon	4 Ad. 3"	135 - 140
HP-605	6" Manşon	5 Ad. 3"	135 - 185



Yarı Otomatik / Hidrosiklonlu ve İkiz Plastik Disk Filtreli Sistemler

ÜRÜN KODU	GİRİŞ/ÇIKIŞ (INCH)	FİLTRE SAYISI VE ÇAPI	DEBİ (M3/H) MİN. - MAX.
HP-423	4" Manşon	2 Ad. 3"	55 - 85
HP-524	5" Manşon	2 Ad. 4"	100 - 120
HP-534	5" Manşon	3 Ad. 4"	100 - 135
HP-634	6" Manşon	3 Ad. 4"	135 - 160
HP-644	6" Manşon	4 Ad. 4"	135 - 185
HP-654	6" Manşon	5 Ad. 4"	135 - 195
HP-844	8" Flanş	4 Ad. 4"	200 - 250
HP-854	8" Flanş	5 Ad. 4"	200 - 300



Yarı Otomatik / Hidrosiklonlu ve Metal Disk Filtreli Sistemler

ÜRÜN KODU	GİRİŞ/ÇIKIŞ (INCH)	FİLTRE SAYISI VE ÇAPI	DEBİ (M3/H) MİN. - MAX.
HY-423	4" Manşon	2 Ad. 3"	55 - 70
HY-433	4" Manşon	3 Ad. 3"	55 - 85
HY-534	5" Manşon	3 Ad. 4"	100 - 135
HY-644	6" Manşon	4 Ad. 4"	135 - 150
HY-654	6" Manşon	5 Ad. 4"	135 - 185

Hidrosiklon (Seperatör)

Tam Otomatik / Hidrosiklonlu ve Tek Plastik Disk Filtreli Sistemler



ÜRÜN KODU	GİRİŞ/ÇIKIŞ (INCH)	FİLTRE SAYISI VE ÇAPI	DEBİ (M3/H) MİN. - MAX.
HPO-302	3" Manşon	2 Ad. 3"	25 - 45
HPO-402	4" Manşon	2 Ad. 3"	55 - 70
HPO-403	4" Manşon	3 Ad. 3"	55 - 85
HPO-504	5" Manşon	4 Ad. 3"	100 - 130
HPO-604	6" Manşon	4 Ad. 3"	135 - 140
HPO-605	6" Manşon	5 Ad. 3"	135 - 185

Tam Otomatik / Hidrosiklonlu ve İkiz Plastik Disk Filtreli Sistemler



ÜRÜN KODU	GİRİŞ/ÇIKIŞ (INCH)	FİLTRE SAYISI VE ÇAPI	DEBİ (M3/H) MİN. - MAX.
HPO-423	4" Manşon	2 Ad. 3"	55 - 85
HPO-524	5" Manşon	2 Ad. 4"	100 - 120
HPO-534	5" Manşon	3 Ad. 4"	100 - 135
HPO-634	6" Manşon	3 Ad. 4"	135 - 160
HPO-644	6" Manşon	4 Ad. 4"	135 - 185
HPO-654	6" Manşon	5 Ad. 4"	135 - 195
HPO-844	8" Flanş	4 Ad. 4"	200 - 250
HPO-854	8" Flanş	5 Ad. 4"	200 - 300

Tam Otomatik / Hidrosiklonlu ve Metal Disk Filtreli Sistemler



ÜRÜN KODU	GİRİŞ/ÇIKIŞ (INCH)	FİLTRE SAYISI VE ÇAPI	DEBİ (M3/H) MİN. - MAX.
HYO-423	4" Manşon	2 Ad. 3"	55 - 70
HYO-433	4" Manşon	3 Ad. 3"	55 - 85
HYO-534	5" Manşon	3 Ad. 4"	100 - 135
HYO-644	6" Manşon	4 Ad. 4"	135 - 150
HYO-654	6" Manşon	5 Ad. 4"	135 - 185

Hidrosiklon (Seperatör)



Yarı Otomatik / Primesiklonlu ve İkiz Plastik Disk Filtreli Platformlu Sistemler

ÜRÜN KODU	GİRİŞ/ÇIKIŞ (INCH)	FİLTRESAYISI VE ÇAPI	DEBİ (M3/H) MİN. - MAX.	GÜBRE TANKI	PLATFORM
PP-423-P	4" Manşon	2 Ad. 3"	55 - 85	GY-200	MP-005
PP-524-P	5" Manşon	2 Ad. 4"	100 - 120	GY-200	MP-005
PP-534-P	5" Manşon	3 Ad. 4"	100 - 135	GY-300	MP-006
PP-634-P	6" Manşon	3 Ad. 4"	135 - 160	GY-300	MP-006
PP-644-P	6" Manşon	4 Ad. 4"	135 - 185	GY-300	MP-006
PP-654-P	6" Manşon	5 Ad. 4"	135 - 195	GY-500	MP-006
PP-844-P	8" Flanş	4 Ad. 4"	200 - 250	GY-500	MP-006
PP-854-P	8" Flanş	5 Ad. 4"	200 - 300	GY-500	MP-006



Yarı Otomatik / Seperatörlü ve İkiz Plastik Disk Filtreli Platformlu Sistemler

ÜRÜN KODU	GİRİŞ/ÇIKIŞ (INCH)	FİLTRE SAYISI VE ÇAPI	DEBİ (M3/H) MİN. - MAX.	GÜBRE TANKI	PLATFORM
SP-423-P	4" Manşon	2 Ad. 3"	55 - 85	GY-200	MP-005
SP-524-P	5" Manşon	2 Ad. 4"	100 - 120	GY-200	MP-005
SP-534-P	5" Manşon	3 Ad. 4"	100 - 135	GY-300	MP-006
SP-634-P	6" Manşon	3 Ad. 4"	135 - 160	GY-300	MP-006
SP-644-P	6" Manşon	4 Ad. 4"	135 - 185	GY-300	MP-006
SP-654-P	6" Manşon	5 Ad. 4"	135 - 195	GY-500	MP-006
SP-844-P	6" Manşon	4 Ad. 4"	200 - 250	GY-500	MP-006
SP-854-P	8" Flanş	5 Ad. 4"	200 - 300	GY-500	MP-006



Yarı Otomatik / Hidrosiklonlu ve İkiz Plastik Disk Filtreli Platformlu Sistemler

ÜRÜN KODU	GİRİŞ/ÇIKIŞ (INCH)	FİLTRE SAYISI VE ÇAPI	DEBİ (M3/H) MİN. - MAX.	GÜBRE TANKI	PLATFORM
HP-423-P	4" Manşon	2 Ad. 3"	55 - 85	GY-200	MP-005
HP-524-P	5" Manşon	2 Ad. 4"	100 - 120	GY-200	MP-005
HP-534-P	5" Manşon	3 Ad. 4"	100 - 135	GY-300	MP-006
HP-634-P	6" Manşon	3 Ad. 4"	135 - 160	GY-300	MP-006
HP-644-P	6" Manşon	4 Ad. 4"	135 - 185	GY-300	MP-006
HP-654-P	6" Manşon	5 Ad. 4"	135 - 195	GY-500	MP-006
HP-844-P	8" Flanş	4 Ad. 4"	200 - 250	GY-500	MP-006
HP-854-P	8" Flanş	5 Ad. 4"	200 - 300	GY-500	MP-006

Hidrosiklon (Seperatör)



Tam Otomatik / Primesiklonlu ve İkiz Plastik Disk Filtreli Platformlu Sistemler

ÜRÜN KODU	GİRİŞ/ÇIKIŞ (INCH)	FİLTRE SAYISI VE ÇAPI	DEBİ (M3/H) MİN. - MAX.	GÜBRE TANKI	PLATFORM
PPO-423-P	4" Manşon	2 Ad. 3"	55 - 85	GY-200	MP-005
PPO-524-P	5" Manşon	2 Ad. 4"	100 - 120	GY-200	MP-005
PPO-534-P	5" Manşon	3 Ad. 4"	100 - 135	GY-300	MP-006
PPO-634-P	6" Manşon	3 Ad. 4"	135 - 160	GY-300	MP-006
PPO-644-P	6" Manşon	4 Ad. 4"	135 - 185	GY-300	MP-006
PPO-654-P	6" Manşon	5 Ad. 4"	135 - 195	GY-500	MP-006
PPO-844-P	8" Flanş	4 Ad. 4"	200 - 250	GY-500	MP-006
PPO-854-P	8" Flanş	5 Ad. 4"	200 - 300	GY-500	MP-006



Tam Otomatik / Seperatörlü ve İkiz Plastik Disk Filtreli Platformlu Sistemler

ÜRÜN KODU	GİRİŞ/ÇIKIŞ (INCH)	FİLTRE SAYISI VE ÇAPI	DEBİ (M3/H) MİN. - MAX.	GÜBRE TANKI	PLATFORM
SPO-423-P	4" Manşon	2 Ad. 3"	55 - 85	GY-200	MP-005
SPO-524-P	5" Manşon	2 Ad. 4"	100 - 120	GY-200	MP-005
SPO-534-P	5" Manşon	3 Ad. 4"	100 - 135	GY-300	MP-006
SPO-634-P	6" Manşon	3 Ad. 4"	135 - 160	GY-300	MP-006
SPO-644-P	6" Manşon	4 Ad. 4"	135 - 185	GY-300	MP-006
SPO-654-P	6" Manşon	5 Ad. 4"	135 - 195	GY-500	MP-006
SPO-844-P	6" Manşon	4 Ad. 4"	200 - 250	GY-500	MP-006
SPO-854-P	8" Flanş	5 Ad. 4"	200 - 300	GY-500	MP-006



Tam Otomatik / Hidrosiklonlu ve İkiz Plastik Disk Filtreli Platformlu Sistemler

ÜRÜN KODU	GİRİŞ/ÇIKIŞ (INCH)	FİLTRE SAYISI VE ÇAPI	DEBİ (M3/H) MİN. - MAX.	GÜBRE TANKI	PLATFORM
HPO-423-P	4" Manşon	2 Ad. 3"	55 - 85	GY-200	MP-005
HPO-524-P	5" Manşon	2 Ad. 4"	100 - 120	GY-200	MP-005
HPO-534-P	5" Manşon	3 Ad. 4"	100 - 135	GY-300	MP-006
HPO-634-P	6" Manşon	3 Ad. 4"	135 - 160	GY-300	MP-006
HPO-644-P	6" Manşon	4 Ad. 4"	135 - 185	GY-300	MP-006
HPO-654-P	6" Manşon	5 Ad. 4"	135 - 195	GY-500	MP-006
HPO-844-P	8" Flanş	4 Ad. 4"	200 - 250	GY-500	MP-006
HPO-854-P	8" Flanş	5 Ad. 4"	200 - 300	GY-500	MP-006

Hidrosiklon (Seperatör)



Yarı Otomatik / Çoklu Metal Hidrosiklonlu İkiz Plastik Disk Filtreli Sistemler

ÜRÜN KODU	GİRİŞ/ÇIKIŞ (INCH)	FİLTRE MİKTARI	HİDROSİKLOKON MİKTARI	DEBİ (M3/H) MİN. - MAX.
HH-423	4" Manşon	2 Ad. 3"	2 Ad. 3"	60 - 80
HH-524	5" Manşon	2 Ad. 4"	3 Ad. 3"	90 - 120
HH-534	5" Manşon	3 Ad. 4"	3 Ad. 3"	90 - 135
HH-644	6" Manşon	4 Ad. 4"	4 Ad. 3"	120 - 180
HH-654	6" Manşon	5 Ad. 4"	5 Ad. 3"	150 - 220
HH-854	8" Flanş	5 Ad. 4"	3 Ad. 4"	165 - 255



Yarı Otomatik / Çoklu Plastik Hidrosiklonlu İkiz Plastik Disk Filtreli Sistemler

ÜRÜN KODU	GİRİŞ/ÇIKIŞ (INCH)	FİLTRE MİKTARI	HİDROSİKLOKON MİKTARI	DEBİ (M3/H) MİN. - MAX.
HF-423	4" Manşon	2 Ad. 3"	2 Ad. 3"	60 - 80
HF-524	5" Manşon	2 Ad. 4"	3 Ad. 3"	90 - 120
HF-534	5" Manşon	3 Ad. 4"	3 Ad. 3"	90 - 135
HF-644	6" Manşon	4 Ad. 4"	4 Ad. 3"	120 - 180
HF-654	6" Manşon	5 Ad. 4"	5 Ad. 3"	150 - 220



Yarı Otomatik / Çoklu Metal Hidrosiklonlu İkiz Plastik Disk Filtreli Platformlu Sistemler

ÜRÜN KODU	GİRİŞ/ÇIKIŞ (INCH)	FİLTRE SAYISI VE ÇAPI	DEBİ (M3/H) MİN. - MAX.	GÜBRE TANKI	PLATFORM
HH-423-P	4" Manşon	2 Ad. 3"	60 - 80	GY-200	MP-005
HH-524-P	5" Manşon	2 Ad. 4"	90 - 120	GY-200	MP-005
HH-534-P	5" Manşon	3 Ad. 4"	90 - 135	GY-300	MP-006
HH-644-P	6" Manşon	4 Ad. 4"	120 - 180	GY-300	MP-006
HH-654-P	6" Manşon	5 Ad. 4"	150 - 220	GY-500	MP-006
HH-854-P	8" Flanş	5 Ad. 4"	165 - 255	GY-500	MP-006

Hidrosiklon (Seperatör)



Tam Otomatik / Çoklu Metal Hidrosiklonlu İkiz Plastik Disk Filtreli Sistemler

ÜRÜN KODU	GİRİŞ/ÇIKIŞ (INCH)	FİLTRE MİKTARI	HİDROSİKLON MİKTARI	DEBİ (M3/H) MİN. - MAX.
HHO-423	4" Manşon	2 Ad. 3"	2 Ad. 3"	60 - 80
HHO-524	5" Manşon	2 Ad. 4"	3 Ad. 3"	90 - 120
HHO-534	5" Manşon	3 Ad. 4"	3 Ad. 3"	90 - 135
HHO-644	6" Manşon	4 Ad. 4"	4 Ad. 3"	120 - 180
HHO-654	6" Manşon	5 Ad. 4"	5 Ad. 3"	150 - 220
HHO-854	8" Flanş	5 Ad. 4"	3 Ad. 4"	165 - 255



Tam Otomatik / Çoklu Plastik Hidrosiklonlu İkiz Plastik Disk Filtreli Sistemler

ÜRÜN KODU	GİRİŞ/ÇIKIŞ (INCH)	FİLTRE MİKTARI	HİDROSİKLON MİKTARI	DEBİ (M3/H) MİN. - MAX.
HFO-423	4" Manşon	2 Ad. 3"	2 Ad. 3"	60 - 80
HFO-524	5" Manşon	2 Ad. 4"	3 Ad. 3"	90 - 120
HFO-534	5" Manşon	3 Ad. 4"	3 Ad. 3"	90 - 135
HFO-644	6" Manşon	4 Ad. 4"	4 Ad. 3"	120 - 180
HFO-654	6" Manşon	5 Ad. 4"	5 Ad. 3"	150 - 220



Tam Otomatik / Çoklu Metal Hidrosiklonlu İkiz Plastik Disk Filtreli Platformlu Sistemler

ÜRÜN KODU	GİRİŞ/ÇIKIŞ (INCH)	FİLTRE SAYISI VE ÇAPI	DEBİ (M3/H) MİN. - MAX.	GÜBRE TANKI	PLATFORM
HHO-423-P	4" Manşon	2 Ad. 3"	60 - 80	GY-200	MP-005
HHO-524-P	5" Manşon	2 Ad. 4"	90 - 120	GY-200	MP-005
HHO-534-P	5" Manşon	3 Ad. 4"	90 - 135	GY-300	MP-006
HHO-644-P	6" Manşon	4 Ad. 4"	120 - 180	GY-300	MP-006
HHO-654-P	6" Manşon	5 Ad. 4"	150 - 220	GY-500	MP-006
HHO-854-P	8" Flanş	5 Ad. 4"	165 - 255	GY-500	MP-006

GRAVEL FILTRERE





heray.com.tr

GRAVEL FİLTRE VE SİSTEMLERİ



GRAVEL FİLTRE VE SİSTEMLERİ



Bağlantı Çeşitleri
Flanş, Viktaulik

Not: Giriş - Çıkış bağlantıları viktauliktir. Farklı bir bağlantı ihtiyacınızı sipariş verirken belirtiniz.

Manifolt Tip / Gravel Filtreler

ÜRÜN KODU	GİRİŞ/ÇIKIŞ (INCH)	GÖVDE ÇAPI	DEBİ (M3/H) MİN. - MAX.
YM-324	3" / DN80	24" / 60 cm	18 - 40
YM-424	4" / DN100	24" / 60 cm	20 - 40
YM-330	3" / DN80	30" / 75 cm	21 - 50
YM-430	4" / DN100	30" / 75 cm	23 - 50
YM-336	3" / DN80	36" / 90 cm	32 - 65
YM-436	4" / DN100	36" / 90 cm	34 - 65
YM-448	4" / DN100	48" / 120 cm	60 - 90
YM-460	4" / DN100	60" / 150 cm	80 - 150
YM-660	6" / DN150	60" / 150 cm	100 - 150



Not: Giriş - Çıkış bağlantıları manşondur. Farklı bir bağlantı ihtiyacınızı sipariş verirken belirtiniz.

By-Pass Tip / Plastik Disk Filtreli Gravel Sistemler

ÜRÜN KODU	GİRİŞ/ÇIKIŞ (INCH)	GÖVDE ÇAPI	DEBİ (M3/H) MİN. - MAX.
YP-220	2" / DN50	20" / 50 cm	8 - 18
YP-250	2 1/2" / DN75	24" / 60 cm	14 - 30
YP-324	3" / DN80	24" / 60 cm	18 - 40
YP-326	3" / DN80	24" / 60 cm	18 - 40
YP-424	4" / DN100	24" / 60 cm	20 - 40
YP-336	3" / DN80	36" / 90 cm	32 - 45
YP-436	4" / DN100	36" / 90 cm	34 - 65



Not: Giriş - Çıkış bağlantıları manşondur. Farklı bir bağlantı ihtiyacınızı sipariş verirken belirtiniz.

By-Pass Tip / Metal Disk Filtreli Gravel Sistemler

ÜRÜN KODU	GİRİŞ/ÇIKIŞ (INCH)	GÖVDE ÇAPI	DEBİ (M3/H) MİN. - MAX.
YF-220	2" / DN50	20" / 50 cm	8 - 18
YF-250	2 1/2" / DN75	24" / 60 cm	14 - 30
YF-324	3" / DN80	24" / 60 cm	18 - 40
YF-424	4" / DN100	24" / 60 cm	20 - 40
YF-336	3" / DN80	36" / 90 cm	32 - 45
YF-436	4" / DN100	36" / 90 cm	34 - 65

GRAVEL FİLTRE VE SİSTEMLERİ



Single Tip / Gravel Filtreler

ÜRÜN KODU	GİRİŞ/ÇIKIŞ (INCH)	GÖVDE ÇAPI	DEBİ (M3/H) MİN. - MAX.
YS-112	1" / DN25	12" 32 CM	3,5 - 5
YS-116	1.5" / DN40	16" 40 CM	5 - 9
YS-220	2" / DN50	20" / 50 cm	8 - 25
YS-224	2" / DN50	24" / 60 cm	14 - 30
YS-254	2 1/2" / DN75	24" / 60 cm	14 - 35
YS-324	3" / DN80	24" / 60 cm	18 - 40
YS-424	4" / DN100	24" / 60 cm	20 - 40
YS-336	3" / DN80	36" / 90 cm	32 - 65
YS-436	4" / DN100	36" / 90 cm	34 - 65

Bağlantı Çeşitleri
Flanş, Viktaulik, Manşon

Not: Giriş - Çıkış bağlantıları manşondur. Farklı bir bağlantı ihtiyacınızı sipariş verirken belirtiniz.

By-Pass Tip / Primesiklon ve Plastik Disk Filtreli Gravel Sistemler



ÜRÜN KODU	GİRİŞ/ÇIKIŞ (INCH)	GÖVDE ÇAPI	DEBİ (M3/H) MİN. - MAX.
YPP-220	2" / DN50	20" / 50 cm	8 - 18
YPP-250	2 1/2" / DN75	24" / 60 cm	14 - 30
YPP-324	3" / DN80	24" / 60 cm	18 - 40
YPP-326	3" / DN80	24" / 60 cm	18 - 40
YPP-424	4" / DN100	24" / 60 cm	20 - 40
YPP-336	3" / DN80	36" / 90 cm	32 - 45
YPP-436	4" / DN100	36" / 90 cm	34 - 65

Not: Giriş - Çıkış bağlantıları manşondur. Farklı bir bağlantı ihtiyacınızı sipariş verirken belirtiniz.

By-Pass Tip / Hidrosiklon ve Plastik Disk Filtreli Gravel Sistemler



ÜRÜN KODU	GİRİŞ/ÇIKIŞ (INCH)	GÖVDE ÇAPI	DEBİ (M3/H) MİN. - MAX.
YHP-220	2" / DN50	20" / 50 cm	8 - 18
YHP-250	2 1/2" / DN75	24" / 60 cm	14 - 30
YHP-324	3" / DN80	24" / 60 cm	18 - 40
YHP-326	3" / DN80	24" / 60 cm	18 - 40
YHP-424	4" / DN100	24" / 60 cm	20 - 40
YHP-336	3" / DN80	36" / 90 cm	32 - 45
YHP-436	4" / DN100	36" / 90 cm	34 - 65

Not: Giriş - Çıkış bağlantıları manşondur. Farklı bir bağlantı ihtiyacınızı sipariş verirken belirtiniz.

GRAVEL FİLTRE VE SİSTEMLERİ



Yarı Otomatik / Plastik Disk Filtreli Gravel Sistemler

ÜRÜN KODU	GİRİŞ/ÇIKIŞ (INCH)	FİLTRE SAYISI VE ÇAPI	DİSK FİLTRE SAYISI VE KODU	DEBİ (M3/H) MİN. - MAX.
YKP-462	4" / Manşon	2 Ad. 3"(24")	2 Ad. PKDS-30	40 - 80
YKP-563	5" / Manşon	3 Ad. 3"(24")	3 Ad. PKDS-30	70 - 110
YKP-663	6" / Manşon	3 Ad. 3"(24")	3 Ad. PKDS-30	70 - 120
YKP-593	5" / Manşon	3 Ad. 3"(36")	3 Ad. PXDS-30	105 - 130
YKP-693	6" / Manşon	3 Ad. 3"(36")	3 Ad. PXDS-30	105 - 140
YKP-664	6" / Manşon	4 Ad. 3"(24")	4 Ad. PKDS-30	120 - 160
YKP-665	6" / Manşon	5 Ad. 3"(24")	5 Ad. PKDS-30	120 - 190
YKP-694	6" / Manşon	4 Ad. 3"(36")	4 Ad. PXDS-30	140 - 185
YKP-866	8" / FLANŞ	6 Ad. 3"(24")	6 Ad. PKDS-30	140 - 240
YKP-867	8" / FLANŞ	7 Ad. 3"(24")	7 Ad. PKDS-30	160 - 280
YKP-895	8" / FLANŞ	5 Ad. 3"(36")	5 Ad. PXDS-30	175 - 280
YKP-896	8" / FLANŞ	6 Ad. 3"(36")	6 Ad. PXDS-30	200 - 320



Tam Otomatik / Plastik Disk Filtreli Gravel Sistemler

ÜRÜN KODU	GİRİŞ/ÇIKIŞ (INCH)	FİLTRE SAYISI VE ÇAPI	DİSK FİLTRE SAYISI VE KODU	DEBİ (M3/H) MİN. - MAX.
YKPO-462	4" / Manşon	2 Ad. 3"(24")	2 Ad. PKDS-30	40 - 80
YKPO-563	5" / Manşon	3 Ad. 3"(24")	3 Ad. PKDS-30	70 - 110
YKPO-663	6" / Manşon	3 Ad. 3"(24")	3 Ad. PKDS-30	70 - 120
YKPO-593	5" / Manşon	3 Ad. 3"(36")	3 Ad. PXDS-30	105 - 130
YKPO-693	6" / Manşon	3 Ad. 3"(36")	3 Ad. PXDS-30	105 - 140
YKPO-664	6" / Manşon	4 Ad. 3"(24")	4 Ad. PKDS-30	120 - 160
YKPO-665	6" / Manşon	5 Ad. 3"(24")	5 Ad. PKDS-30	120 - 190
YKPO-694	6" / Manşon	4 Ad. 3"(36")	4 Ad. PXDS-30	140 - 185
YKPO-866	8" / FLANŞ	6 Ad. 3"(24")	6 Ad. PKDS-30	140 - 240
YKPO-867	8" / FLANŞ	7 Ad. 3"(24")	7 Ad. PKDS-30	160 - 280
YKPO-895	8" / FLANŞ	5 Ad. 3"(36")	5 Ad. PXDS-30	175 - 280
YKPO-896	8" / FLANŞ	6 Ad. 3"(36")	6 Ad. PXDS-30	200 - 320

GRAVEL FİLTRE VE SİSTEMLERİ

Yarı Otomatik / Primesiklon ve Plastik Disk Filtreli Gravel Sistemler



ÜRÜN KODU	GİRİŞ/ÇIKIŞ (INCH)	FİLTRE SAYISI VE ÇAPI	DİSK FİLTRE SAYISI VE KODU	DEBİ (M3/H) MİN. - MAX.
YPP-462	4" / Manşon	2 Ad. 3"(24")	2 Ad. PKDS-30	55 - 80
YPP-563	5" / Manşon	3 Ad. 3"(24")	3 Ad. PKDS-30	90 - 110
YPP-663	6" / Manşon	3 Ad. 3"(24")	3 Ad. PKDS-30	90 - 120
YPP-593	5" / Manşon	3 Ad. 3"(36")	3 Ad. PXDS-30	100 - 130
YPP-693	6" / Manşon	3 Ad. 3"(36")	3 Ad. PXDS-30	120 - 160
YPP-664	6" / Manşon	4 Ad. 3"(24")	4 Ad. PKDS-30	120 - 160
YPP-665	6" / Manşon	5 Ad. 3"(24")	5 Ad. PKDS-30	120 - 185
YPP-694	6" / Manşon	4 Ad. 3"(36")	4 Ad. PXDS-30	140 - 185
YPP-866	8" / FLANŞ	6 Ad. 3"(24")	6 Ad. PKDS-30	200 - 240
YPP-867	8" / FLANŞ	7 Ad. 3"(24")	7 Ad. PKDS-30	200 - 280
YPP-895	8" / FLANŞ	5 Ad. 3"(36")	5 Ad. PXDS-30	200 - 300
YPP-896	8" / FLANŞ	6 Ad. 3"(36")	6 Ad. PXDS-30	200 - 320

Tam Otomatik / Primesiklon ve Plastik Disk Filtreli Gravel Sistemler



ÜRÜN KODU	GİRİŞ/ÇIKIŞ (INCH)	FİLTRE SAYISI VE ÇAPI	DİSK FİLTRE SAYISI VE KODU	DEBİ (M3/H) MİN. - MAX.
YPO-462	4" / Manşon	2 Ad. 3"(24")	2 Ad. PKDS-30	55 - 80
YPO-563	5" / Manşon	3 Ad. 3"(24")	3 Ad. PKDS-30	90 - 110
YPO-663	6" / Manşon	3 Ad. 3"(24")	3 Ad. PKDS-30	90 - 120
YPO-593	5" / Manşon	3 Ad. 3"(36")	3 Ad. PXDS-30	100 - 130
YPO-693	6" / Manşon	3 Ad. 3"(36")	3 Ad. PXDS-30	120 - 160
YPO-664	6" / Manşon	4 Ad. 3"(24")	4 Ad. PKDS-30	120 - 160
YPO-665	6" / Manşon	5 Ad. 3"(24")	5 Ad. PKDS-30	120 - 185
YPO-694	6" / Manşon	4 Ad. 3"(36")	4 Ad. PXDS-30	140 - 185
YPO-866	8" / FLANŞ	6 Ad. 3"(24")	6 Ad. PKDS-30	200 - 240
YPO-867	8" / FLANŞ	7 Ad. 3"(24")	7 Ad. PKDS-30	200 - 280
YPO-895	8" / FLANŞ	5 Ad. 3"(36")	5 Ad. PXDS-30	200 - 300
YPO-896	8" / FLANŞ	6 Ad. 3"(36")	6 Ad. PXDS-30	200 - 320

GRAVEL FİLTRE VE SİSTEMLERİ



Yarı Otomatik / Separatör ve Plastik Disk Filtreli Gravel Sistemler

ÜRÜN KODU	GİRİŞ/ÇIKIŞ (INCH)	FİLTRE SAYISI VE ÇAPI	DİSK FİLTRE SAYISI VE KODU	DEBİ (M3/H) MİN. - MAX.
YSP-462	4" / Manşon	2 Ad. 3"(24")	2 Ad. PKDS-30	55 - 80
YSP-563	5" / Manşon	3 Ad. 3"(24")	3 Ad. PKDS-30	90 - 110
YSP-663	6" / Manşon	3 Ad. 3"(24")	3 Ad. PKDS-30	90 - 120
YSP-593	5" / Manşon	3 Ad. 3"(36")	3 Ad. PXDS-30	100 - 130
YSP-693	6" / Manşon	3 Ad. 3"(36")	3 Ad. PXDS-30	120 - 160
YSP-664	6" / Manşon	4 Ad. 3"(24")	4 Ad. PKDS-30	120 - 160
YSP-665	6" / Manşon	5 Ad. 3"(24")	5 Ad. PKDS-30	120 - 185
YSP-694	6" / Manşon	4 Ad. 3"(36")	4 Ad. PXDS-30	140 - 185
YSP-866	8" / FLANŞ	6 Ad. 3"(24")	6 Ad. PKDS-30	200 - 240
YSP-867	8" / FLANŞ	7 Ad. 3"(24")	7 Ad. PKDS-30	200 - 280
YSP-895	8" / FLANŞ	5 Ad. 3"(36")	5 Ad. PXDS-30	200 - 300
YSP-896	8" / FLANŞ	6 Ad. 3"(36")	6 Ad. PXDS-30	200 - 320



Tam Otomatik / Separatör ve Plastik Disk Filtreli Gravel Sistemler

ÜRÜN KODU	GİRİŞ/ÇIKIŞ (INCH)	FİLTRE SAYISI VE ÇAPI	DİSK FİLTRE SAYISI VE KODU	DEBİ (M3/H) MİN. - MAX.
YSPO-462	4" / Manşon	2 Ad. 3"(24")	2 Ad. PKDS-30	55 - 80
YSPO-563	5" / Manşon	3 Ad. 3"(24")	3 Ad. PKDS-30	90 - 110
YSPO-663	6" / Manşon	3 Ad. 3"(24")	3 Ad. PKDS-30	90 - 120
YSPO-593	5" / Manşon	3 Ad. 3"(36")	3 Ad. PXDS-30	100 - 130
YSPO-693	6" / Manşon	3 Ad. 3"(36")	3 Ad. PXDS-30	120 - 160
YSPO-664	6" / Manşon	4 Ad. 3"(24")	4 Ad. PKDS-30	120 - 160
YSPO-665	6" / Manşon	5 Ad. 3"(24")	5 Ad. PKDS-30	120 - 185
YSPO-694	6" / Manşon	4 Ad. 3"(36")	4 Ad. PXDS-30	140 - 185
YSPO-866	8" / FLANŞ	6 Ad. 3"(24")	6 Ad. PKDS-30	200 - 240
YSPO-867	8" / FLANŞ	7 Ad. 3"(24")	7 Ad. PKDS-30	200 - 280
YSPO-895	8" / FLANŞ	5 Ad. 3"(36")	5 Ad. PXDS-30	200 - 300
YSPO-896	8" / FLANŞ	6 Ad. 3"(36")	6 Ad. PXDS-30	200 - 320

GRAVEL FİLTRE VE SİSTEMLERİ

Yarı Otomatik / Hidrosiklon ve Plastik Disk Filtreli Gravel Sistemler



ÜRÜN KODU	GİRİŞ/ÇIKIŞ (INCH)	FİLTRE SAYISI VE ÇAPI	DİSK FİLTRE SAYISI VE KODU	DEBİ (M3/H) MİN. - MAX.
YHP-462	4" / Manşon	2 Ad. 3"(24")	2 Ad. PKDS-30	55 - 80
YHP-563	5" / Manşon	3 Ad. 3"(24")	3 Ad. PKDS-30	90 - 110
YHP-663	6" / Manşon	3 Ad. 3"(24")	3 Ad. PKDS-30	90 - 120
YHP-593	5" / Manşon	3 Ad. 3"(36")	3 Ad. PXDS-30	100 - 130
YHP-693	6" / Manşon	3 Ad. 3"(36")	3 Ad. PXDS-30	120 - 160
YHP-664	6" / Manşon	4 Ad. 3"(24")	4 Ad. PKDS-30	120 - 160
YHP-665	6" / Manşon	5 Ad. 3"(24")	5 Ad. PKDS-30	120 - 185
YHP-694	6" / Manşon	4 Ad. 3"(36")	4 Ad. PXDS-30	140 - 185
YHP-866	8" / FLANŞ	6 Ad. 3"(24")	6 Ad. PKDS-30	200 - 240
YHP-867	8" / FLANŞ	7 Ad. 3"(24")	7 Ad. PKDS-30	200 - 280
YHP-895	8" / FLANŞ	5 Ad. 3"(36")	5 Ad. PXDS-30	200 - 300
YHP-896	8" / FLANŞ	6 Ad. 3"(36")	6 Ad. PXDS-30	200 - 320

Tam Otomatik / Hidrosiklon ve Plastik Disk Filtreli Gravel Sistemler



ÜRÜN KODU	GİRİŞ/ÇIKIŞ (INCH)	FİLTRE SAYISI VE ÇAPI	DİSK FİLTRE SAYISI VE KODU	DEBİ (M3/H) MİN. - MAX.
YHPO-462	4" / Manşon	2 Ad. 3"(24")	2 Ad. PKDS-30	55 - 80
YHPO-563	5" / Manşon	3 Ad. 3"(24")	3 Ad. PKDS-30	90 - 110
YHPO-663	6" / Manşon	3 Ad. 3"(24")	3 Ad. PKDS-30	90 - 120
YHPO-593	5" / Manşon	3 Ad. 3"(36")	3 Ad. PXDS-30	100 - 130
YHPO-693	6" / Manşon	3 Ad. 3"(36")	3 Ad. PXDS-30	120 - 160
YHPO-664	6" / Manşon	4 Ad. 3"(24")	4 Ad. PKDS-30	120 - 160
YHPO-665	6" / Manşon	5 Ad. 3"(24")	5 Ad. PKDS-30	120 - 185
YHPO-694	6" / Manşon	4 Ad. 3"(36")	4 Ad. PXDS-30	140 - 185
YHPO-866	8" / FLANŞ	6 Ad. 3"(24")	6 Ad. PKDS-30	200 - 240
YHPO-867	8" / FLANŞ	7 Ad. 3"(24")	7 Ad. PKDS-30	200 - 280
YHPO-895	8" / FLANŞ	5 Ad. 3"(36")	5 Ad. PXDS-30	200 - 300
YHPO-896	8" / FLANŞ	6 Ad. 3"(36")	6 Ad. PXDS-30	200 - 320

GRAVEL FİLTRE VE SİSTEMLERİ



Tam Otomatik / Primescreen Filtreli Gravel Otomatik Filtre

ÜRÜN KODU	GİRİŞ/ÇIKIŞ (INCH)	FİLTRE SAYISI VE ÇAPI	OTOMATİK FİLTRE	DEBİ (M3/H) MİN. - MAX.
YTO-462	4" / Manşon	2 Ad. 3"(24")	TFS-416	40 - 80
YTO-563	5" / Manşon	3 Ad. 3"(24")	TFS-516	70 - 110
YTO-663	6" / Manşon	3 Ad. 3"(24")	TFS-616	70 - 120
YTO-593	5" / Manşon	3 Ad. 3"(36")	TFS-519	105 - 130
YTO-693	6" / Manşon	3 Ad. 3"(36")	TFS-619	105 - 140
YTO-664	6" / Manşon	4 Ad. 3"(24")	TFS-616	120 - 160
YTO-665	6" / Manşon	5 Ad. 3"(24")	TFS-619	120 - 190
YTO-694	6" / Manşon	4 Ad. 3"(36")	TFS-619	140 - 185
YTO-866	8" / FLANŞ	6 Ad. 3"(24")	TFS-819	140 - 240
YTO-867	8" / FLANŞ	7 Ad. 3"(24")	TFS-819	160 - 280
YTO-895	8" / FLANŞ	5 Ad. 3"(36")	TFS-819	175 - 280
YTO-896	8" / FLANŞ	6 Ad. 3"(36")	TFS-819	200 - 320



Tam Otomatik / Primesiklon ve Primescreen Filtreli Gravel Sistemler

ÜRÜN KODU	GİRİŞ/ÇIKIŞ (INCH)	FİLTRE SAYISI VE ÇAPI	OTOMATİK FİLTRE	DEBİ (M3/H) MİN. - MAX.
YTPO-462	4" / Manşon	2 Ad. 3"(24")	TFS-416	55 - 80
YTPO-563	5" / Manşon	3 Ad. 3"(24")	TFS-516	90 - 110
YTPO-663	6" / Manşon	3 Ad. 3"(24")	TFS-616	90 - 120
YTPO-593	5" / Manşon	3 Ad. 3"(36")	TFS-519	100 - 130
YTPO-693	6" / Manşon	3 Ad. 3"(36")	TFS-619	120 - 160
YTPO-664	6" / Manşon	4 Ad. 3"(24")	TFS-616	120 - 160
YTPO-665	6" / Manşon	5 Ad. 3"(24")	TFS-619	120 - 185
YTPO-694	6" / Manşon	4 Ad. 3"(36")	TFS-619	140 - 185
YTPO-866	8" / FLANŞ	6 Ad. 3"(24")	TFS-819	200 - 240
YTPO-867	8" / FLANŞ	7 Ad. 3"(24")	TFS-819	200 - 280
YTPO-895	8" / FLANŞ	5 Ad. 3"(36")	TFS-819	200 - 300
YTPO-896	8" / FLANŞ	6 Ad. 3"(36")	TFS-819	200 - 320

GRAVEL FİLTRE VE SİSTEMLERİ

Tam Otomatik / Separatör ve Primescreen Filtreli Gravel Sistemler



ÜRÜN KODU	GİRİŞ/ÇIKIŞ (INCH)	FİLTRE SAYISI VE ÇAPI	OTOMATİK FİLTRE	DEBİ (M3/H) MİN. - MAX.
YTSO-462	4" / Manşon	2 Ad. 3"(24")	TFS-416	55 - 80
YTSO-563	5" / Manşon	3 Ad. 3"(24")	TFS-516	90 - 110
YTSO-663	6" / Manşon	3 Ad. 3"(24")	TFS-616	90 - 120
YTSO-593	5" / Manşon	3 Ad. 3"(36")	TFS-519	100 - 130
YTSO-693	6" / Manşon	3 Ad. 3"(36")	TFS-619	120 - 160
YTSO-664	6" / Manşon	4 Ad. 3"(24")	TFS-616	120 - 160
YTSO-665	6" / Manşon	5 Ad. 3"(24")	TFS-619	120 - 185
YTSO-694	6" / Manşon	4 Ad. 3"(36")	TFS-619	140 - 185
YTSO-866	8" / FLANŞ	6 Ad. 3"(24")	TFS-819	200 - 240
YTSO-867	8" / FLANŞ	7 Ad. 3"(24")	TFS-819	200 - 280
YTSO-895	8" / FLANŞ	5 Ad. 3"(36")	TFS-819	200 - 300
YTSO-896	8" / FLANŞ	6 Ad. 3"(36")	TFS-819	200 - 320

Tam Otomatik / Hidrosiklon ve Primescreen Filtreli Gravel Sistemler



ÜRÜN KODU	GİRİŞ/ÇIKIŞ (INCH)	FİLTRE SAYISI VE ÇAPI	OTOMATİK FİLTRE	DEBİ (M3/H) MİN. - MAX.
YTHO-462	4" / Manşon	2 Ad. 3"(24")	TFS-416	55 - 80
YTHO-563	5" / Manşon	3 Ad. 3"(24")	TFS-516	90 - 110
YTHO-663	6" / Manşon	3 Ad. 3"(24")	TFS-616	90 - 120
YTHO-593	5" / Manşon	3 Ad. 3"(36")	TFS-519	100 - 130
YTHO-693	6" / Manşon	3 Ad. 3"(36")	TFS-619	120 - 160
YTHO-664	6" / Manşon	4 Ad. 3"(24")	TFS-616	120 - 160
YTHO-665	6" / Manşon	5 Ad. 3"(24")	TFS-619	120 - 185
YTHO-694	6" / Manşon	4 Ad. 3"(36")	TFS-619	140 - 185
YTHO-866	8" / FLANŞ	6 Ad. 3"(24")	TFS-819	200 - 240
YTHO-867	8" / FLANŞ	7 Ad. 3"(24")	TFS-819	200 - 280
YTHO-895	8" / FLANŞ	5 Ad. 3"(36")	TFS-819	200 - 300
YTHO-896	8" / FLANŞ	6 Ad. 3"(36")	TFS-819	200 - 320

FİLTRE VE GÜBRE TANIKLARI





heray.com.tr

FİLTRELER VE GÜBRE TANKLARI

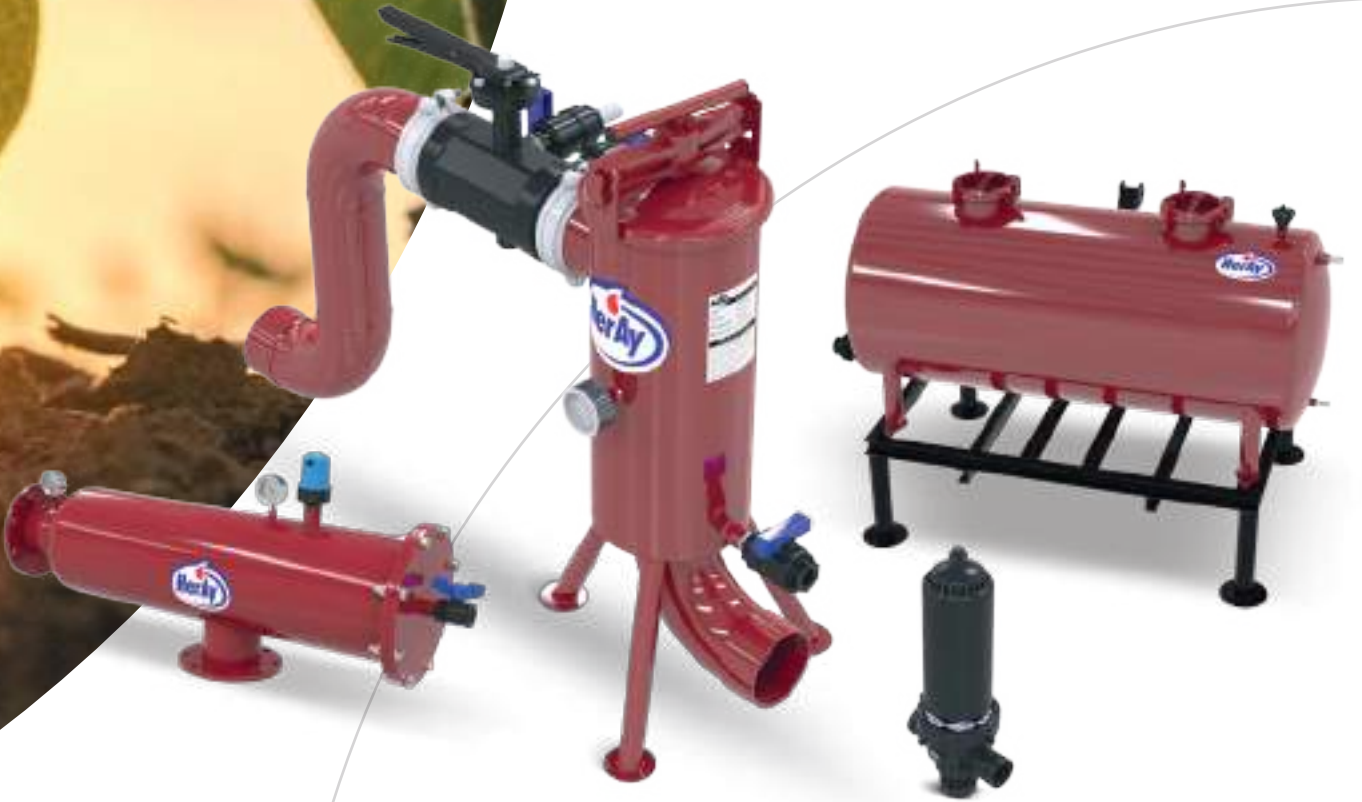

GÜBRE TANKLARI



Dik Tip / Gübre Tankları

ÜRÜN KODU	BAĞLANTISI	KAPASİTE (LİTRE)
GD-60	1"	60
GD-100	1"	120
GD-200	1"	200



Yatay Tip / Gübre Tankları

ÜRÜN KODU	BAĞLANTISI	KAPASİTE (LİTRE)
GY-100	1"	120
GY-200	1"	200
GY-300	1"	300
GY-400	1"	400
GY-500	1"	500



Platformlu / Gübre Tankları

ÜRÜN KODU	BAĞLANTISI	KAPASİTE (LİTRE)
GY-500-P	1"	500
GY-800-P	2"	800
GY-1000-P	2"	1000

Not: Tüm gübre tankı modellerimizin kapak yapısı resimdeki gibidir. Farklı kapak talebiniz olursa sipariş verirken belirtiniz.

GÜBRE TANKLARI



Set Tipi / Gübre Tankları

ÜRÜN KODU	MANİFOLD BAĞLANTISI	GÜBRE TANKI BAĞLANTISI	KAPASİTE (LİTRE)
GB-104	4" Manşon	1" Manşon	120
GB-205	5" Manşon	1" Manşon	200
GB-206	6" Manşon	1" Manşon	200
GB-305	5" Manşon	1" Manşon	300
GB-306	6" Manşon	1" Manşon	300
GB-406	6" Manşon	1" Manşon	400
GB-506	6" Manşon	1" Manşon	500



Karıştırıcı ve Pompalı Paslanmaz Gübre Tankı Seti

ÜRÜN KODU	KAPASİTE (LİTRE)
GMX-1000	1000 lt
GMX-2000	2000 lt



Ayaklı Tip / Gübrelemeli Metal Disk Filtreler

ÜRÜN KODU	GİRİŞ/ÇIKIŞ (INCH)	DİSK KARTUŞ (YÜKSEKLİK)	DEBİ (M3/H) MAX
FG-258	2 1/2" Manşon	35 cm.	30
FG-348	3" Manşon	40 cm.	40
FG-358	3" Manşon	50 cm.	50
FG-458	4" Manşon	50 cm	60
FG-468	4" Manşon	60 cm	80

FİLTRELER

Plastik Fitreler



Bağlantı Çeşitleri

- Dış Dişli
- Viktaulik

ÜRÜN KODU	GİRİŞ/ÇIKIŞ (INCH)	FİLTASYON ALANI (CM2)	DEBİ (M3/H) MAX
PKD-20	2"	Disk / 1300	30
PKDS-20	2"	Disk / 1800	35
PKD-25	2 1/2"	Disk / 1300	35
PKDS-25	2 1/2"	Disk / 1800	40
PKD-30	3"	Disk / 1300	45
PKDS-30	3"	Disk / 1800	50
PKE-20	2"	Elek / 1140	30
PKES-20	2"	Elek / 1500	35
PKE-25	2 1/2"	Elek / 1140	35
PKES-25	2 1/2"	Elek / 1500	40
PKE-30	3"	Elek / 1140	45
PKES-30	3"	Elek / 1500	50

İkiz Plastik Fitreler



Bağlantı Çeşitleri

- Dış Dişli
- Viktaulik

ÜRÜN KODU	GİRİŞ/ÇIKIŞ (INCH)	FİLTASYON ALANI (CM2)	DEBİ (M3/H) MAX
PXD-30	3"	Disk / 2600	50
PXDS-30	3"	Disk / 3600	60
PXD-40	4"	Disk / 2600	70
PXDS-40	4"	Disk / 3600	80
PXE-30	3"	Elek / 2200	50
PXES-30	3"	Elek / 3000	60
PXE-40	4"	Elek / 2200	70
PXES-40	4"	Elek / 3000	80

Hat Tipi / Mini Plastik Filtreler



ÜRÜN KODU	GİRİŞ/ÇIKIŞ (INCH)	FİLTASYON ALANI (CM2)	DEBİ (M3/H) MAX
PHE-034	3/4"	Elek	5
PHE-100	1"	Elek	6
PHE-150	1 1/2"	Elek	15
PHE-200	2"	Elek	20
PHD-150	1 1/2"	Disk	15
PHD-200	2"	Disk	20

FİLTRELER



Dik Tip / Metal Disk Filtreler

ÜRÜN KODU	GİRİŞ/ÇIKIŞ (INCH)	DİSK KARTUŞ (YÜKSEKLİK)	DEBİ (M3/H) MAX
FA-208	2" Manşon	25 cm.	20
FA-258	2 1/2" Manşon	35 cm.	30
FA-348	3" Manşon	40 cm.	40
FA-358	3" Manşon	50 cm.	50
FA-458	4" Manşon	50 cm.	60
FA-468	4" Manşon	60 cm.	80



Ayaklı Tip / Metal Disk Filtreler

ÜRÜN KODU	GİRİŞ/ÇIKIŞ (INCH)	DİSK KARTUŞ (YÜKSEKLİK)	DEBİ (M3/H) MAX
FD-208	2" Manşon	25 cm.	20
FD-258	2 1/2" Manşon	35 cm.	30
FD-348	3" Manşon	40 cm.	40
FD-358	3" Manşon	50 cm.	50
FD-458	4" Manşon	50 cm.	60
FD-468	4" Manşon	60 cm.	80



Yatay Tip / Metal Disk Filtreler

ÜRÜN KODU	GİRİŞ/ÇIKIŞ (INCH)	KARTUŞ	DEBİ (M3/H) MAX
FY-208	2" Manşon	25 cm.	20
FY-258	2 1/2" Manşon	35 cm.	30
FY-348	3" Manşon	40 cm.	40
FY-358	3" Manşon	50 cm.	50
FY-458	4" Manşon	50 cm.	60
FY-468	4" Manşon	60 cm.	80

FİLTRELER



Yatay Tip / Metal Elek Filtreler

ÜRÜN KODU	GİRİŞ/ÇIKIŞ (INCH)	FİLTASYON YÜZEY ALANI	DEBİ (M3/H) MAX
FE-208	2" Manşon	850 Cm ²	20
FE-258	2 1/2" Manşon	1275 Cm ²	30
FE-348	3" Manşon	1700 Cm ²	40
FE-458	4" Manşon	2550 Cm ²	60

Bağlantı Çeşitleri:
Flanş, Manşon, Viktaulik

NOT: Standart olarak bağlantımız manşon üretilmektedir, farklı taleplerinizi sipariş verirken belirtiniz.



Galvaniz Kaplı Pivot Filtresi

ÜRÜN KODU	GİRİŞ/ÇIKIŞ (INCH)	FİLTASYON HASSASİYETİ	DEBİ (M3/H) MAX
PF-2754	4" FLANŞ	1000 - 2000 Mikron	60 - 80
PF-4756	6" FLANŞ	1000 - 2000 Mikron	100 - 150
PF-7008	8" FLANŞ	1000 - 2000 Mikron	160 - 200
PF-12008	8" FLANŞ	1000 - 2000 Mikron	250 - 300
PF-120010	10" FLANŞ	1000 - 2000 Mikron	250 - 350
PF-200012	12" FLANŞ	1000 - 2000 Mikron	400 - 500

NOT: Standart olarak 2000 mikron üretilmektedir, farklı taleplerinizi sipariş verirken belirtiniz.



L Tipi



Y Tipi

Manuel Elek Fitre

ÜRÜN KODU	GİRİŞ/ÇIKIŞ (INCH)	MODEL	FİLTASYON YÜZEY ALANI	DEBİ (M3/H) MAX
PFL-400	4" Viktaulik	L Tipi	2500 Cm ²	80
PFL-600	6" Viktaulik	L Tipi	4000 Cm ²	160
PFL-800	8" Viktaulik	L Tipi	6400 Cm ²	250
PFY-400	4 Viktaulik	Y Tipi	2500 Cm ²	80
PFY-600	6" Viktaulik	Y Tipi	4000 Cm ²	160
PFY-800	8" Viktaulik	Y Tipi	6400 Cm ²	250

NOT: Filtrasyon hassasiyeti standart olarak 130 mikron üretilmektedir, farklı mikron ve bağlantı taleplerinizi sipariş verirken belirtiniz.

FİLTRELER

Pompa Emiř Filtresi



ÜRÜN KODU	GİRİŞ/ÇIKIŞ (INCH)	ÖNERİLEN MAX. DEBİ (M3/H)	
		1200 MİKRON	2500 MİKRON
EF-300	3" FLANŞ	40	60
EF-400	4" FLANŞ	80	100
EF-500	5" FLANŞ	120	150
EF-600	6" FLANŞ	150	190
EF-800	8" FLANŞ	300	380
EF-1000	10" FLANŞ	500	630
EF-1200	12" FLANŞ	700	880
EF-1400	14" FLANŞ	950	1100
EF-1600	16" FLANŞ	1200	1400
EF-1800	18" FLANŞ	1750	2100
EF-2000	20" FLANŞ	2200	2750

NOT: Pompa emiř filtresinde klape yoktur.

Kombi Tip / Metal Disk Filtreler



ÜRÜN KODU	GİRİŞ/ÇIKIŞ (INCH)	KARTUŞ	DEBİ (M3/H) MAX
KF-402	4" Manşon	2 Ad.	50
KF-403	4" Manşon	3 Ad.	70
KF-503	5" Manşon	3 Ad.	110
KF-603	6" Manşon	3 Ad.	120
KF-604	6" Manşon	4 Ad.	140

Kombi Tip / Metal Disk Filtreli Hidrosiklon Sistemler



ÜRÜN KODU	GİRİŞ/ÇIKIŞ (INCH)	KARTUŞ	DEBİ (M3/H) MAX
HM-402	4" Manşon	2 Ad.	50
HM-403	4" Manşon	3 Ad.	70
HM-503	5" Manşon	3 Ad.	110
HM-603	6" Manşon	3 Ad.	120
HM-604	6" Manşon	4 Ad.	140

PLASTIK DISK FILTRELI SISTEMLER





heray.com.tr

PLASTİK DİSK FİLTRELİ SİSTEMLER



PLASTİK DİSK FİLTRELİ SİSTEMLER



Yarı Otomatik / Manifoldlu ve Plastik Disk Filtreli Sistemler

ÜRÜN KODU	GİRİŞ/ÇIKIŞ (INCH)	FİLTRE SAYISI VE ÇAPI	DEBİ (M3/H) MİN. - MAX.
MP-402	4" Manşon	2 Ad. 3"	55 - 70
MP-403	4" Manşon	3 Ad. 3"	55 - 85
MP-504	5" Manşon	4 Ad. 3"	100-130
MP-605	6" Manşon	5 Ad. 3"	135 - 170
MP-606	6" Manşon	6 Ad. 3"	135 - 200



Yarı Otomatik / Manifoldlu ve İkiz Plastik Disk Filtreli Sistemler

ÜRÜN KODU	GİRİŞ/ÇIKIŞ (INCH)	FİLTRE SAYISI VE ÇAPI	DEBİ (M3/H) MİN. - MAX.
MP-423	4" Manşon	2 Ad. 3"	55 - 85
MP-524	5" Manşon	2 Ad. 4"	100 - 120
MP-534	5" Manşon	3 Ad. 4"	100 - 140
MP-634	6" Manşon	3 Ad. 4"	135 - 160
MP-644	6" Manşon	4 Ad. 4"	135 - 185
MP-654	6" Manşon	5 Ad. 4"	135 - 195
MP-844	8" Flanş	4 Ad. 4"	190 - 240
MP-854	8" Flanş	5 Ad. 4"	190 - 300



Tam Otomatik / P100 Manifoldlu Plastik Disk Filtreli Sistemler

ÜRÜN KODU	GİRİŞ/ÇIKIŞ (INCH)	FİLTRE SAYISI VE ÇAPI	DEBİ (M3/H) MİN. - MAX.
MPO-402P	4" Manşon	2 Ad. 3"	55 - 70
MPO-403P	4" Manşon	3 Ad. 3"	55 - 85
MPO-504P	5" Manşon	4 Ad. 3"	100-130
MPO-605P	6" Manşon	5 Ad. 3"	135 - 170
MPO-606P	6" Manşon	6 Ad. 3"	135 - 200

PLASTİK DİSK FİLTRELİ SİSTEMLER



Tam Otomatik / Manifoldlu ve Plastik Disk Filtreli Sistemler

ÜRÜN KODU	GİRİŞ/ÇIKIŞ (INCH)	FİLTRE SAYISI VE ÇAPI	DEBİ (M3/H) MİN. - MAX.
MPO-402	4" Manşon	2 Ad. 3"	55 - 70
MPO-403	4" Manşon	3 Ad. 3"	55 - 85
MPO-504	5" Manşon	4 Ad. 3"	100-130
MPO-605	6" Manşon	5 Ad. 3"	135 - 170
MPO-606	6" Manşon	6 Ad. 3"	135 - 200



Tam Otomatik / Manifoldlu ve İkiz Plastik Disk Filtreli Sistemler

ÜRÜN KODU	GİRİŞ/ÇIKIŞ (INCH)	FİLTRE SAYISI VE ÇAPI	DEBİ (M3/H) MİN. - MAX.
MPO-423	4" Manşon	2 Ad. 3"	55 - 85
MPO-524	5" Manşon	2 Ad. 4"	100 - 120
MPO-534	5" Manşon	3 Ad. 4"	100 - 140
MPO-634	6" Manşon	3 Ad. 4"	135 - 160
MPO-644	6" Manşon	4 Ad. 4"	135 - 185
MPO-654	6" Manşon	5 Ad. 4"	135 - 195
MPO-844	8" Flanş	4 Ad. 4"	190 - 240
MPO-854	8" Flanş	5 Ad. 4"	190 - 300



Tam Otomatik /P100 Manifoldlu İkiz Plastik Disk Filtreli Sistemler

ÜRÜN KODU	GİRİŞ/ÇIKIŞ (INCH)	FİLTRE SAYISI VE ÇAPI	DEBİ (M3/H) MİN. - MAX.
MPO-423P	4" Manşon	2 Ad. 3"	55 - 85
MPO-524P	5" Manşon	2 Ad. 4"	100 - 120
MPO-534P	5" Manşon	3 Ad. 4"	100 - 140
MPO-634P	6" Manşon	3 Ad. 4"	135 - 160
MPO-644P	6" Manşon	4 Ad. 4"	135 - 185
MPO-654P	6" Manşon	5 Ad. 4"	135 - 195
MPO-844P	8" Flanş	4 Ad. 4"	190 - 240
MPO-854P	8" Flanş	5 Ad. 4"	190 - 300

MOBİL PLATFORMLAR





heray.com.tr

MOBİL PLATFORMLAR

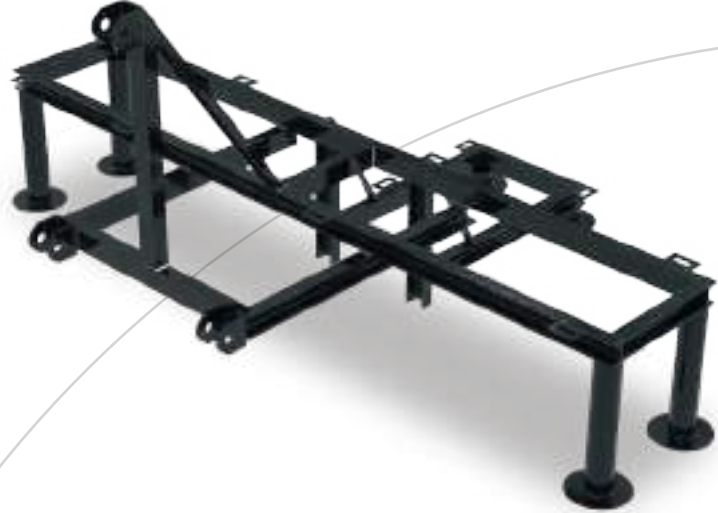

MOBİL PLATFORM



Tek Dingil Makaslı Römork

ÜRÜN KODU

AÇIKLAMA

MP-002

Tek Dingil Makaslı Römork Takımı



Çift Dingil Makaslı Römork

ÜRÜN KODU

AÇIKLAMA

MP-001

Çift Dingil Makaslı Römork Takımı

NOT: Römork ve hidrolik kaldırma platformları ürüne göre özel üretildiği için görseldeki resimler değişiklik gösterebilir.

MOBİL PLATFORM



Ekonomik Model / Tek Dingil Makassız Römork

ÜRÜN KODU	TAVSİYE EDİLEN UYGULAMALAR	AÇIKLAMA
MP-003	Maksimum 3 tanklı (24") Gravel filtre sistemler için uygundur.	Dubleks Kalın Tekerli
MP-004	Hidrosiklonlu ve Disk Filtreli sistemler için uygundur	Kaplamalı Lastik ve Jantlı



MP-005
MP-006



MP-007

Hidrolik Kaldırma Platformu

ÜRÜN KODU	TAVSİYE EDİLEN UYGULAMALAR	AÇIKLAMA
MP-007	Tekli Disk Filtreli sistemler için.	0 -200 Kg Arası
MP-005	İkili Disk Filtreli sistemler için.	0 - 300 Kg Arası
MP-006	Üç ve üzeri Disk Filtreli sistemler için.	0 - 600 Kg Arası

NOT: Römork ve hidrolik kaldırma platformları ürüne göre özel üretildiği için görseldeki resimler değişiklik gösterebilir.

GERİ YIKAMA ÜNİTESİ





heray.com.tr

GERİ YIKAMA KONTROL ÜNİTELERİ VE VANALARI



GERİ YIKAMA KONTROL ÜNİTELERİ



NOT: 8 İstasyon üzeri taleplerinizde iletişime geçiniz.

Geri Yıkama Otomasyon Setleri

ÜRÜN KODU	İSTASYON SAYISI
OPT-02	2 İstasyon
OPT-03	3 İstasyon
OPT-04	4 İstasyon
OPT-05	5 İstasyon
OPT-06	6 İstasyon
OPT-07	7 İstasyon
OPT-08	8 İstasyon

Resimde görünen tüm parçalar setin içinde bulunmaktadır, ihtiyaca göre geri yıkama vanası ve olabilecek diğer parçalar setin içinde değildir.



- 8 İstasyona kadar kolay programlama imkanı
- AC (Elektrik), DC (Pil) ve güneş enerjisi paneli çalışabilme imkanı.
- 30 bar'a dayanıklı, 10 bar'a kadar basınç fark ölçümü yapabilen basınç fark sensörü sayesinde sorunsuz çalışma imkanı.
- İster zaman ayarlı ister basınç fark ayarlı, isterseniz hem zaman hem basınç fark ayarlı özelliğini kullanabilme imkanı.
- Dış hava şartlarına dayanıklı bir yapıdadır.
- Kontrolörü yan tarafında bulunan manuel yıkama düğmesi sayesinde pano kapağını açmadan, manuel yıkama imkanı.
- Manuel yıkama düğmesine yüklenen ekstra özellik sayesinde hidrosiklon kumluk tahliye vanası özelliğini devreye alma ve çıkarma işlemi çok kolay yapılabilmektedir.
- Sürekli ters yıkama döngülerinde bir sorun varsa kontrolör bunu algılar ve zamana göre geri yıkama moduna geçer.
- Kontrolör düşük pil durumunda uyarı verir.

Geri Yıkama Otomasyon Üniteleri

ÜRÜN KODU	İSTASYON SAYISI
OP-01	1 - 8 İstasyon

GERİ YIKAMA KONTROL ÜNİTELERİ



NOT: Android ve IOS için uygulamaları pano üzerindeki karekodu okutarak cihazınıza indirebilirsiniz.

Bluetooth Bağlantılı Geri Yıkama Otomasyon Setleri

ÜRÜN KODU	İSTASYON SAYISI
OPK-01	1 İstasyon
OPK-02	2 İstasyon
OPK-03	3 İstasyon
OPK-04	4 İstasyon
OPK-05	5 İstasyon
OPK-06	6 İstasyon

Resimde görünen tüm parçalar setin içinde bulunmaktadır, ihtiyaca göre geri yıkama vanası ve olabilecek diğer parçalar setin içinde değildir.



- Bluetooth özelliği sayesinde geri yıkama süreçlerini derinlemesine programlama yapabileme olanağı sağlar.
- Bluetooth özelliği sayesinde günde kaç defa geri yıkama yaptığını takip edebileme imkanı.
- 6 İstasyona kadar kolay programlama imkanı
- AC (Elektrik), DC (Pil) ve güneş enerjisi paneli çalışabilme imkanı.
- 30 bar'a dayanıklı, 10 bar'a kadar basınç fark ölçümü yapabilen basınç fark sensörü sayesinde sorunsuz çalışma imkanı.
- İster zaman ayarlı ister basınç fark ayarlı, isterseniz hem zaman hem basınç fark ayarlı özelliğini kullanabilme imkanı.
- Dış hava şartlarına dayanıklı bir yapıdadır.
- Kontrolörü yan tarafında bulunan manuel yıkama düğmesi sayesinde pano kapağını açmadan, manuel yıkama imkanı.
- Manuel yıkama düğmesine yüklenen ekstra özellik sayesinde hidrosiklon kumluk tahliye vanası özelliğini devreye alma ve çıkarma işlemi çok kolay yapılabilmektedir.
- Sürekli ters yıkama döngülerinde bir sorun varsa kontrolör bunu algılar ve zamana göre geri yıkama moduna geçer.
- Kontrolör düşük pil durumunda uyarı verir.

Geri Yıkama Otomasyon Üniteleri

ÜRÜN KODU

İSTASYON SAYISI

OP-02

1 - 6 İstasyon

GERİ YIKAMA VE KONTROL VANALARI



Model 20M Döküm Gövde Geri Yıkama Vanası

ÜRÜN KODU	GİRİŞ/ÇIKIŞ (INCH)	DRENAJ BAĞLANTISI (INCH)
VT-203-MV	3" x 3" Viktaulik	2" BSP İç Dişli
VT-204-MV	4" x 4" Viktaulik	3" BSP İç Dişli



Model 20P Plastik Gövde Geri Yıkama Vanası

ÜRÜN KODU	GİRİŞ/ÇIKIŞ (INCH)	DRENAJ BAĞLANTISI (INCH)
VT-203-PV	3" x 3" Viktaulik	2" BSP İç Dişli
VT-204-PV	4" x 4" Viktaulik	3" BSP İç Dişli



Model 50M Döküm Gövde Geri Yıkama Vanası

ÜRÜN KODU	GİRİŞ/ÇIKIŞ (INCH)	DRENAJ BAĞLANTISI (INCH)
VT-503-MV	3" x 3" Viktaulik	2" BSP İç Dişli
VT-503-MF	3" x 3" Flanş	2" BSP İç Dişli
VT-504-MV	4" x 4" Viktaulik	3" BSP İç Dişli
VT-504-MF	4" x 4" Flanş	3" BSP İç Dişli
VT-514-MF	4" x 4" Viktaulik	4" Viktaulik



Model 10 Hızlı Basınç (Relief) Tahliye Vanası

ÜRÜN KODU	GİRİŞ/ÇIKIŞ (INCH)	GÖVDE CİNSİ
VT-102-M	2" BSP İç Dişli	Döküm Gövde
VT-102-P	2" BSP İç Dişli	Plastik Gövde



Model 30 Hidrolik Vana Gövdesi

ÜRÜN KODU	GİRİŞ/ÇIKIŞ (INCH)	GÖVDE CİNSİ
VT-302	2" BSP İç Dişli	Döküm Gövde

GERİ YIKAMA AKSESUARLARI



Dirsek

ÜRÜN KODU	BAĞLANTI ÖLÇÜSÜ VE TİPİ
FP-101	1/4" - 8 mm
FP-102	1/8" - 8 mm

TE

ÜRÜN KODU	BAĞLANTI ÖLÇÜSÜ VE TİPİ
FP-107	8 - 1/4" - 8 mm
FP-108	8 - 1/2" - 8 mm



Nipel

ÜRÜN KODU	BAĞLANTI ÖLÇÜSÜ VE TİPİ
FP-103	1/4" - 1/4"
FP-104	1/8" - 1/8"
FP-105	1/4" - 1/8"

Rekor Nipel

ÜRÜN KODU	BAĞLANTI ÖLÇÜSÜ VE TİPİ
FP-109	1/4" - 8 mm
FP-110	1/8" - 8 mm



Kör Tapa

ÜRÜN KODU	BAĞLANTI ÖLÇÜSÜ VE TİPİ
FP-106	1/4"

TE

ÜRÜN KODU	BAĞLANTI ÖLÇÜSÜ VE TİPİ
FP-111	8 - 8 - 8 mm



Selenoid Bobin

ÜRÜN KODU	AÇIKLAMA
OYP-001	DC (Pilli) 3 Yollu Selenoid
OYP-002	AC (Elektrikli) 3 Yollu Selenoid



Hidrolik Kontrol Rölesi

ÜRÜN KODU	AÇIKLAMA
OYP-004	3 Konumlu Hidrolik Kontrol Rölesi

VANJA GRUBU

MEKANIK

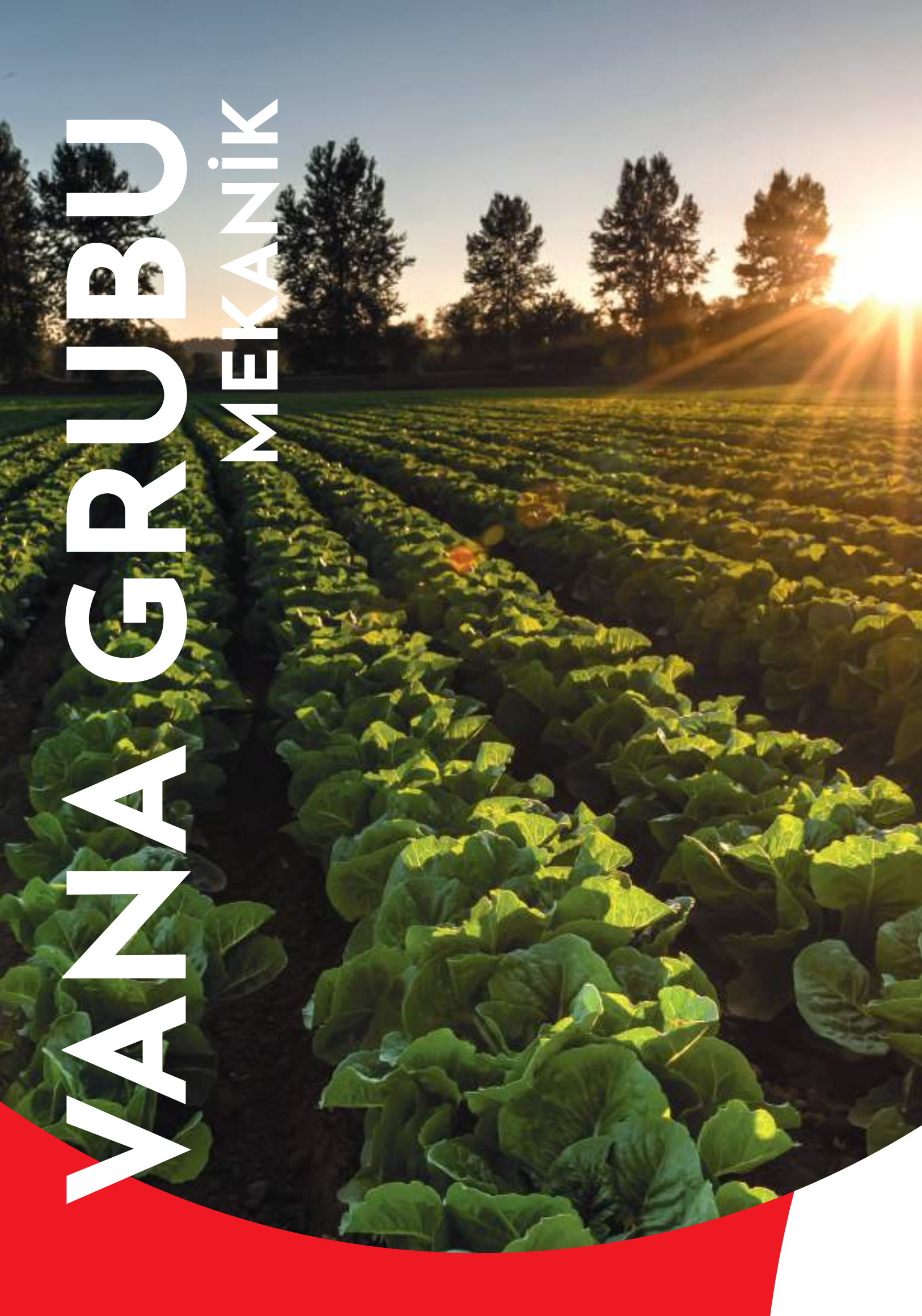



heray.com.tr

VANA GRUBU MEKANİK



VANA GRUBU MEKANİK



Plastik Gvde Ters Yıkama Kelebek Vanalar

ÜRÜN KODU

BAĞLANTISI

VT-302

3"x2" Victaulic

VT-402

4"x2" Victaulic



Plastik Gvde Gübreleme Kelebek Vanalar

ÜRÜN KODU

BAĞLANTISI

VG-250

2 1/2" Victaulic

VG-300

3" Victaulic

VG-400

4" Victaulic

VG-251

2 1/2" İç Diş

VG-301

3" İç Diş

VG-401

4" İç Diş



Plastik Gvde Kelebek Vanalar

ÜRÜN KODU

BAĞLANTISI

VK-251

2 1/2" İç Diş

VK-301

3" İç Diş

VK-401

4" İç Diş

VK-501

5" İç Diş



VANA GRUBU MEKANİK



Wafer Tip Plastik Gvde Kelebek Vanalar

RN KODU	BAĖLANTISI
VW-200	2" Wafer Tip
VW-250	2 1/2" Wafer Tip
VW-300	3" Wafer Tip
VW-400	4" Wafer Tip
VW-500	5" Wafer Tip
VW-600	6" Wafer Tip



Kresel Vanalar

RN KODU	BAĖLANTISI
KV-100	1" KRESEL VANA PLASTİK
KV-200	2" KRESEL VANA PLASTİK



Plastik Gvde Kelebek Vanalar

RN KODU	BAĖLANTISI
VK-311	3" Viktaulik
VK-411	4" Viktaulik



YEDER EK PARÇA

VE AKSESUARLAR

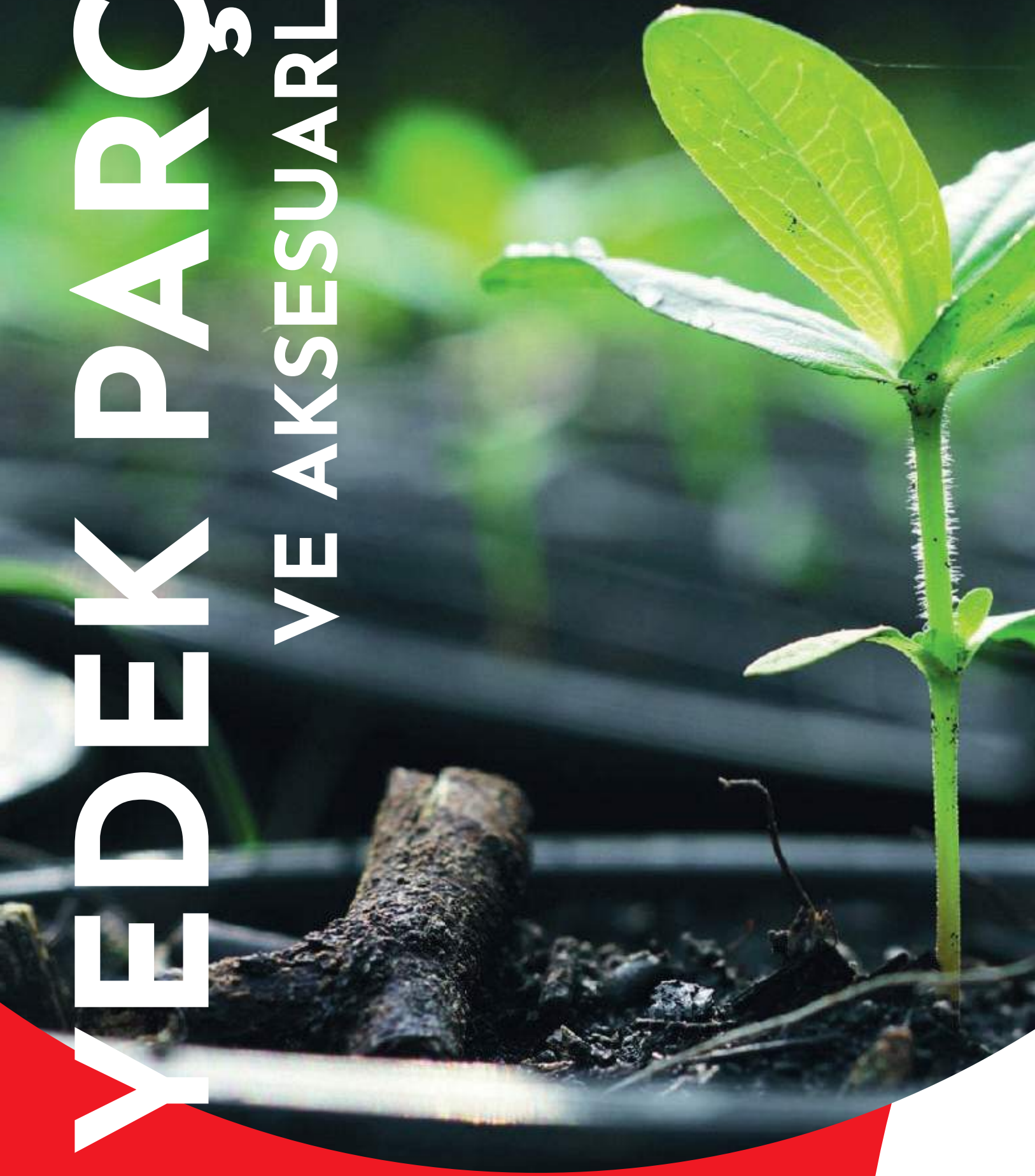



heray.com.tr

YEDEK PARÇA VE AKSESUARLAR



YEDEK PARÇA VE AKSESUARLAR



Döküm Kapak Grubu

ÜRÜN KODU	AÇIKLAMA
FP-009	8" Döküm Kapak
FP-010	8" Döküm Kapak Kilidi
FP-011	8" Döküm Kapak Contası
FP-012	6" Döküm Kapak
FP-013	6" Döküm Kapak Contası



Gübre Tankı Kapağı

ÜRÜN KODU	AÇIKLAMA
FP-080	8" Gübre Tankı Kapağı
FP-081	8" Gübre Tankı Kapak Contası



Hava Vantuzları

ÜRÜN KODU	AÇIKLAMA
FP-004	1/2" Metal Gövde
FP-005	3/4" Plastik Toplu Hava Vantuzu
FP-006	1" Plastik Toplu Hava Vantuzu
FP-007	1" Plastik Çift Etkili Kinetik Vantuz
FP-008	2" Plastik Çift Etkili Kinetik Vantuz

YEDEK PARÇA VE AKSESUARLAR



Çelik Kapak Grubu

ÜRÜN KODU	AÇIKLAMA
FP-014	8" Çelik Kapak
FP-015	8" Çelik Kapak Kilidi
FP-016	8" Çelik Kapak Contası



Victaulic Kelepçeler

ÜRÜN KODU	AÇIKLAMA
FP-120	2" Victaulic Kelepçe
FP-121	2 1/2" Victaulic Kelepçe
FP-122	3" Victaulic Kelepçe
FP-123	4" Victaulic Kelepçe
FP-124	5" Victaulic Kelepçe
FP-125	6" Victaulic Kelepçe
FP-126	8" Victaulic Kelepçe
FP-127	3" Plastik Victaulic Kelepçe
FP-128	4" Plastik Victaulic Kelepçe

Gliserinli Tip



Kuru Tip



Manometreler

ÜRÜN KODU	AÇIKLAMA
FP-001	0-6 Bar Alt Çıkış Q63mm - 1/4" BSP Kuru Manometre
FP-002	0-10 Bar Alt Çıkış Q63mm - 1/4" BSP Gliserinli Manometre
FP-003	0-10 Bar Arka Çıkış Q52mm - 1/4" BSP Gliserinli Manometre

YEDEK PARA VE AKSESUARLAR

Plastik Filtre Ek Paraları



ÜRÜN KODU

AIKLAMA

FP-020

2" Plastik Filtre Alt Gvdesi T-T-T

FP-021

2" Plastik Filtre Alt Gvdesi V-V-T

FP-022

2 1/2" Plastik Filtre Alt Gvdesi T-T-T

FP-023

2 1/2" Plastik Filtre Alt Gvdesi V-V-T

FP-024

3" Plastik Filtre Alt Gvdesi T-T-T

FP-025

3" Plastik Filtre Alt Gvdesi V-V-T

ÜRÜN KODU

AIKLAMA

FP-026

3" İkiz Plastik Filtre Alt Gvdesi T-T

FP-027

3" İkiz Plastik Filtre Alt Gvdesi V-V

FP-028

4" İkiz Plastik Filtre Alt Gvdesi T-T

FP-029

4" İkiz Plastik Filtre Alt Gvdesi V-V

ÜRÜN KODU

AIKLAMA

FP-030

Plastik Filtre Kısa Gvde Tası

FP-031

Plastik Filtre Uzun Gvde Tası

ÜRÜN KODU

AIKLAMA

FP-032

Plastik Filtre Disk Kısa Kartuş (Contalı)

FP-033

Plastik Filtre Disk Uzun Kartuş (Contalı)

FP-034

Plastik Filtre Elek Kısa Kartuş (Contalı)

FP-035

Plastik Filtre Elek Uzun Kartuş (Contalı)

ÜRÜN KODU

AIKLAMA

FP-036

Krom Kelepe

FP-036-P

Plastik Filtre Kelepesi (Plastik)

FP-036-G

Plastik Filtre Kelepesi (Galvanizli)

FP-114

2" Tapa Contalı

FP-038

2 1/2" Tapa Contalı

FP-039

3" Tapa Contalı

FP-112

İ Takım Oringi

FP-113

Tas Contası

YEDEK PARA VE AKSESUARLAR



Metal Filtre Disk Kartuş

ÜRÜN KODU	AIKLAMA
FP-040	25 cm. Disk Kartuş
FP-041	35 cm. Disk Kartuş
FP-042	40 cm. Disk Kartuş
FP-043	50 cm. Disk Kartuş
FP-044	60 cm. Disk Kartuş



Primescreen Yedek Para

ÜRÜN KODU	AIKLAMA
FP-045	Elektronik Kontrol Ünitesi Takımı
FP-75	MP Dikey Tip 2400 cm2 İç Takım
FP-76	LP Yatay Tip 4800 cm2 İç Takım
FP-77	XLP Yatay Tip 7200 cm2 İç Takım
FP-78	Plastik Piston Takımı (LP ve XLP Modeller içindir)
FP-79	Plastik Piston Takımı (MP Modeller içindir)

Flanş Contası



ÜRÜN KODU	AIKLAMA
FP-046	2" Flanş Contası
FP-047	2 1/2" Flanş Contası
FP-048	3" Flanş Contası
FP-049	4" Flanş Contası
FP-050	5" Flanş Contası
FP-051	6" Flanş Contası
FP-052	8" Flanş Contası

YEDEK PARA VE AKSESUARLAR



Flanşlı Manşon

ÜRÜN KODU	AÇIKLAMA
FP-053	4" Flanşlı Manşon
FP-054	5" Flanşlı Manşon
FP-055	6" Flanşlı Manşon
FP-056	8" Flanşlı Manşon

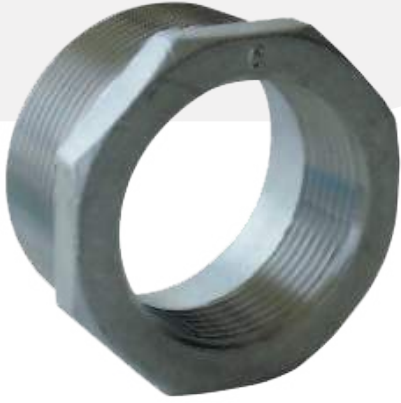

Döküm Redüksiyon

ÜRÜN KODU	AÇIKLAMA
FP-114	4" - 3"
FP-115	5" - 4"
FP-116	6" - 5"



T Tipi Flanşlı Bağlantı

ÜRÜN KODU	AÇIKLAMA
FP-117	4" x 4" x 4" Flanş
FP-118	5" x 5" x 5" Flanş
FP-119	6" x 6" x 6" Flanş
FP-120	8" x 8" x 8" Flanş

YEDEK PARÇA VE AKSESUARLAR

Su Sayacı Manifold Seti



ÜRÜN KODU	AÇIKLAMA
FP-085	4" Flanş
FP-086	5" Flanş
FP-087	6" Flanş
FP-088	8" Flanş



S Tipi Flanşlı Bağlantı

ÜRÜN KODU	AÇIKLAMA
FP-089	4" Flanş
FP-090	5" Flanş
FP-091	6" Flanş
FP-092	8" Flanş

NOT: 2 Dirsek arası boru ölçüsü 80cm'dir. Farklı ölçü taleplerinizi sipariş verirken belirtiniz.

Gravel Filtre Kumu



ÜRÜN KODU	AÇIKLAMA
FP-093	1 - 3 mm Bazalt
FP-094	0.7 - 1,5 mm Bazalt
FP-095	0.7 - 1,5 mm Kuartz

HORTUM SERME

VE TOPLAMA MAKINELERİ





heray.com.tr

HORTUM SERME VE TOPLAMA MAKİNELERİ



HORTUM SERME VE TOPLAMA MAKİNELERİ



Toprak Altı Hortum Serme Makinesi

ÜRÜN KODU	GÖVDE GENİŞLİĞİ	BIÇAK SAYISI
SR15-1-2000-L-F	2 Metre	50cm / 1 Adet
SR15-2-3000-L-F	3 Metre	50cm / 2 Adet
SR15-2-4000-L-F	4 Metre	50cm / 2 Adet
SR15-3-5000-L-F	5 Metre	50cm / 3 Adet

HORTUM SERME VE TOPLAMA MAKİNELERİ



Flexnet Motorlu Hortum Toplama Hız Ayarlı

ÜRÜN KODU

AÇIKLAMA

FP-096

Motorlu - Hız Ayarlı

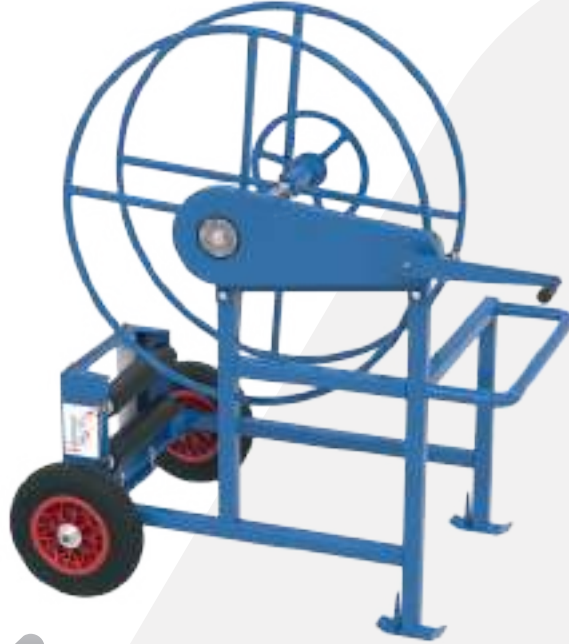

Flexnet Manuel Hortum Toplama

ÜRÜN KODU

AÇIKLAMA

FP-097

Manuel



Suza

Değer Katan Teknoloji